

FRONT VIEW - AP58866

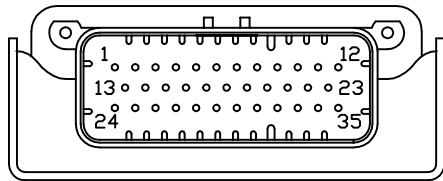

- PIN
1. N/C
  2. N/C
  3. N/C
  4. BLK(W5702) - ROOM 4 IN
  5. N/C
  6. BLK(W5800) - ROOM 1 VACUUM SENSE
  7. N/C
  8. N/C
  9. N/C
  10. N/C
  11. N/C
  12. N/C
  13. BLK(W5100) - GEN RETRACT
  14. N/C
  15. N/C
  16. BLK(W5803) - ROOM 4 VACUUM SENSE
  17. BLK(W5701) - ROOM 1 OUT
  18. N/C
  19. N/C
  20. N/C
  21. CAN SHIELD
  22. YELLOW - CAN HIGH
  23. GREEN - CAN LOW
  24. N/C
  25. N/C
  26. N/C
  27. BLK(W5700) - ROOM 4 OUT
  28. BLK(W5703) - ROOM 1 IN
  29. N/C
  30. N/C
  31. BLK(W5000) - GEN EXTEND
  32. WHT(W6230) - GROUND
  33. RED(W6800) - +12V TO LIMIT SWITCHES
  34. N/C
  35. RED(W6805) - SW. BATTERY

NOTE: WIRE NUMBERS ON THIS SHEET ARE REFERENCED TO HARNESS PLUGS.

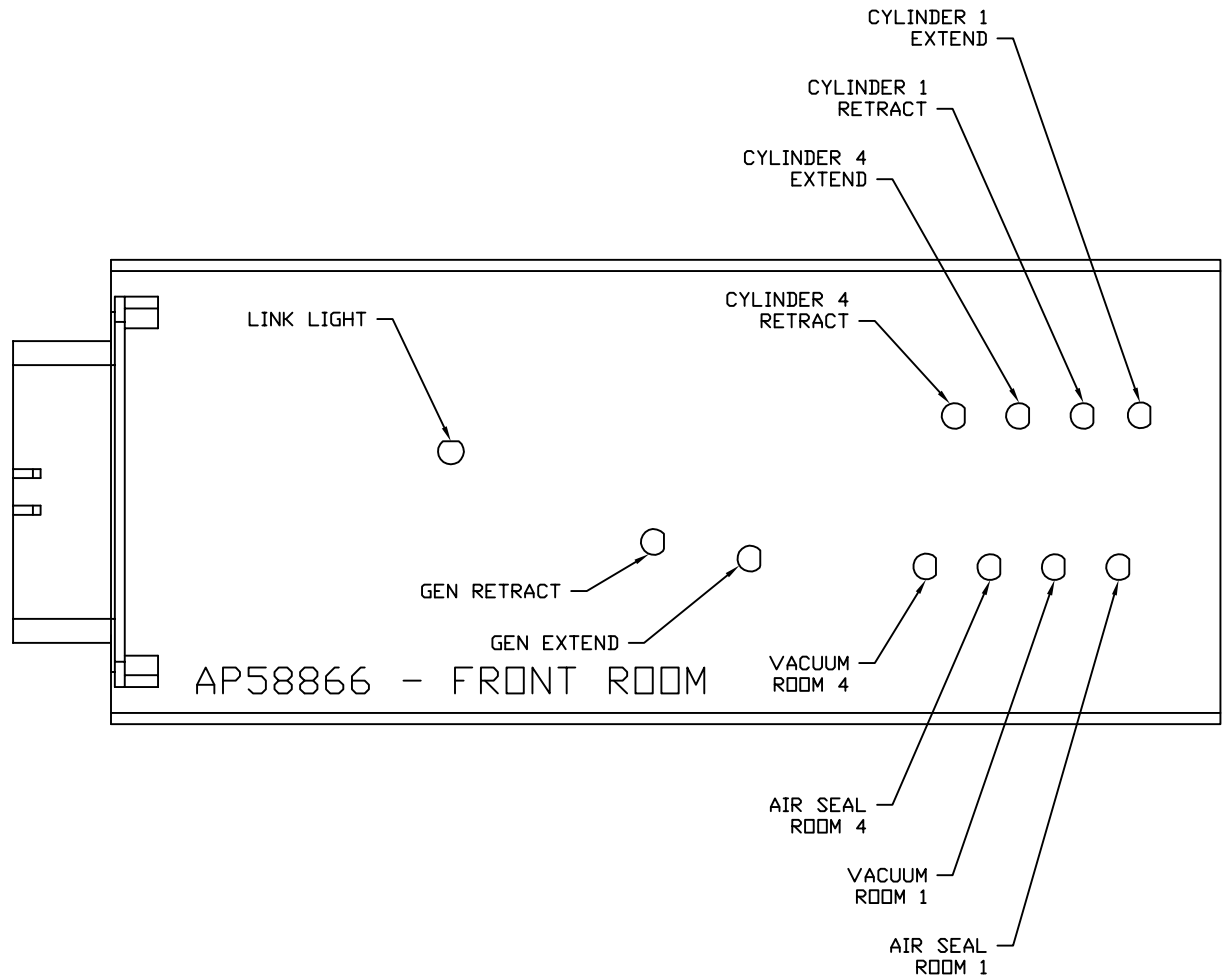

NOTE: INSTALLATION MUST CONFORM TO GOOD SHOP PRACTICES, SAE STANDARDS, RVIA STANDARDS, AND OTHER APPLICABLE STANDARDS.

		<b>HWH</b>		I-80 EXIT 267 SOUTH RT 1 MOSCOW, IOWA 52760	
		SCALE 1:3	DATE 29JAN19	DRAWN BY .	
		SYSTEM SCHEMATIC ELEC			
NO.	DATE	REVISION			
△	29SEP20	WAS AP58696			
△	18JUN20	WAS AP53508			
THE INFORMATION DISCLOSED ON THIS DRAWING IS CONFIDENTIAL AND MUST NOT BE DISCLOSED OR USED IN ANY MANNER WHICH WILL BE DETRIMENTAL TO THE HWH CORPORATION		DRAWING NUMBER MP91444 A/H			

FRONT VIEW - AP58983

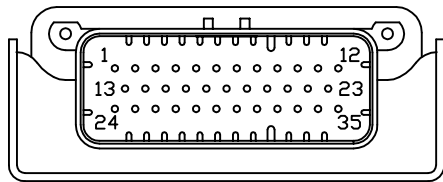

- PIN
1. BLK(W9000) - PARK BRAKE
  2. N/C
  3. BLK(W8101) - 50 LB. PRESSURE SWITCH
  4. BLK(W0100) - LEFT SIDE SENSE
  5. BLK(W0400) - REAR SENSE
  6. BLK(W3000) - RIGHT REAR JACK WARNING SWITCH
  7. BLK(W2200) - RIGHT FRONT JACK PRESSURE SWITCH
  8. N/C
  9. RED(W6805) - SW. BATTERY
  10. N/C
  11. WHT(W6235) - WARNING SWITCH GROUND
  12. N/C
  13. RED(W6110) - IGNITION SENSE
  14. N/C
  15. N/C
  16. BLK(W0300) - RIGHT SIDE SENSE
  17. BLK(W2000) - RIGHT FRONT JACK WARNING SWITCH
  18. BLK(W1200) - LEFT FRONT JACK PRESSURE SWITCH
  19. N/C
  20. WHT(W6230) - TOUCH PANEL GROUND
  21. CAN SHIELD
  22. YELLOW - CAN HIGH
  23. GREEN - CAN LOW
  24. N/C
  25. BLK(W4200) - LEFT REAR JACK PRESSURE SWITCH
  26. BLK(W8100) - 3000 LB. PRESSURE SWITCH
  27. BLK(W0200) - FRONT SENSE
  28. BLK(W1000) - LEFT FRONT JACK WARNING SWITCH
  29. BLK(W4000) - LEFT REAR JACK WARNING SWITCH
  30. BLK(W3200) - RIGHT REAR JACK PRESSURE SWITCH
  31. N/C
  32. WHT(W6231) - LEVEL SENSOR GROUND
  33. RED(W6112) - LEVEL SENSOR POWER
  34. RED(W6111) - TOUCH PANEL POWER
  35. RED(W6110) - IGNITION

NOTE: WIRE NUMBERS ON THIS SHEET ARE REFERENCED TO HARNESS PLUGS.

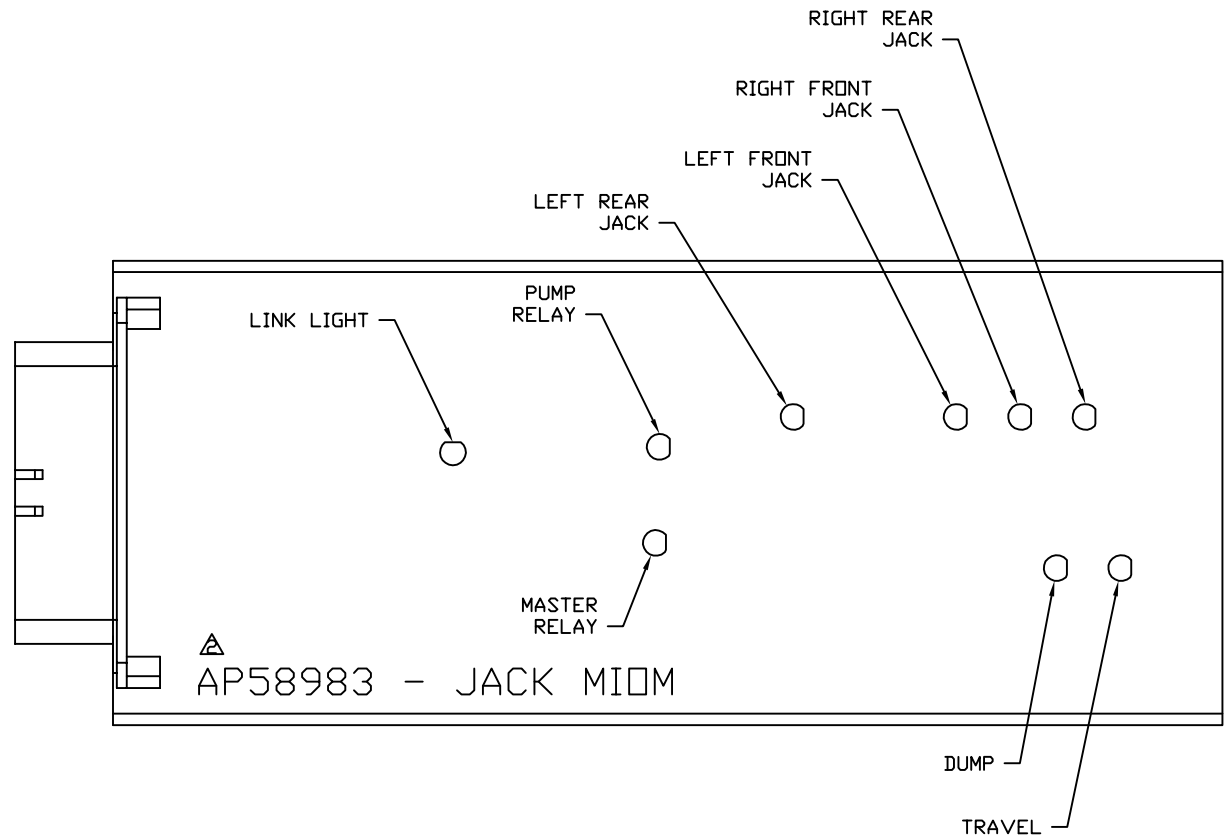

NOTE: INSTALLATION MUST CONFORM TO GOOD SHOP PRACTICES, SAE STANDARDS, RVIA STANDARDS, AND OTHER APPLICABLE STANDARDS.

FRONT VIEW - AP59085-01

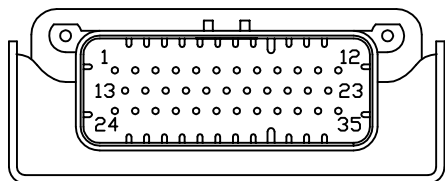

- PIN
1. N/C
  2. N/C
  3. N/C
  4. N/C
  5. N/C
  6. BLK(W5801) - ROOM 2 VACUUM SENSE
  7. N/C
  8. N/C
  9. N/C
  10. N/C
  11. N/C
  12. N/C
  13. N/C
  14. N/C
  15. N/C
  16. N/C
  17. BLK(W5701) - ROOM 2 OUT
  18. N/C
  19. N/C
  20. N/C
  21. CAN SHIELD
  22. YELLOW - CAN HIGH
  23. GREEN - CAN LOW
  24. N/C
  25. N/C
  26. N/C
  27. N/C
  28. BLK(W5703) - ROOM 2 IN
  29. N/C
  30. N/C
  31. N/C
  32. WHT(W6230) - GROUND
  33. RED(W6800) - +12V TO LIMIT SWITCHES
  34. N/C
  35. RED(W6805) - SW. BATTERY

NOTE: WIRE NUMBERS ON THIS SHEET ARE REFERENCED TO HARNESS PLUGS.

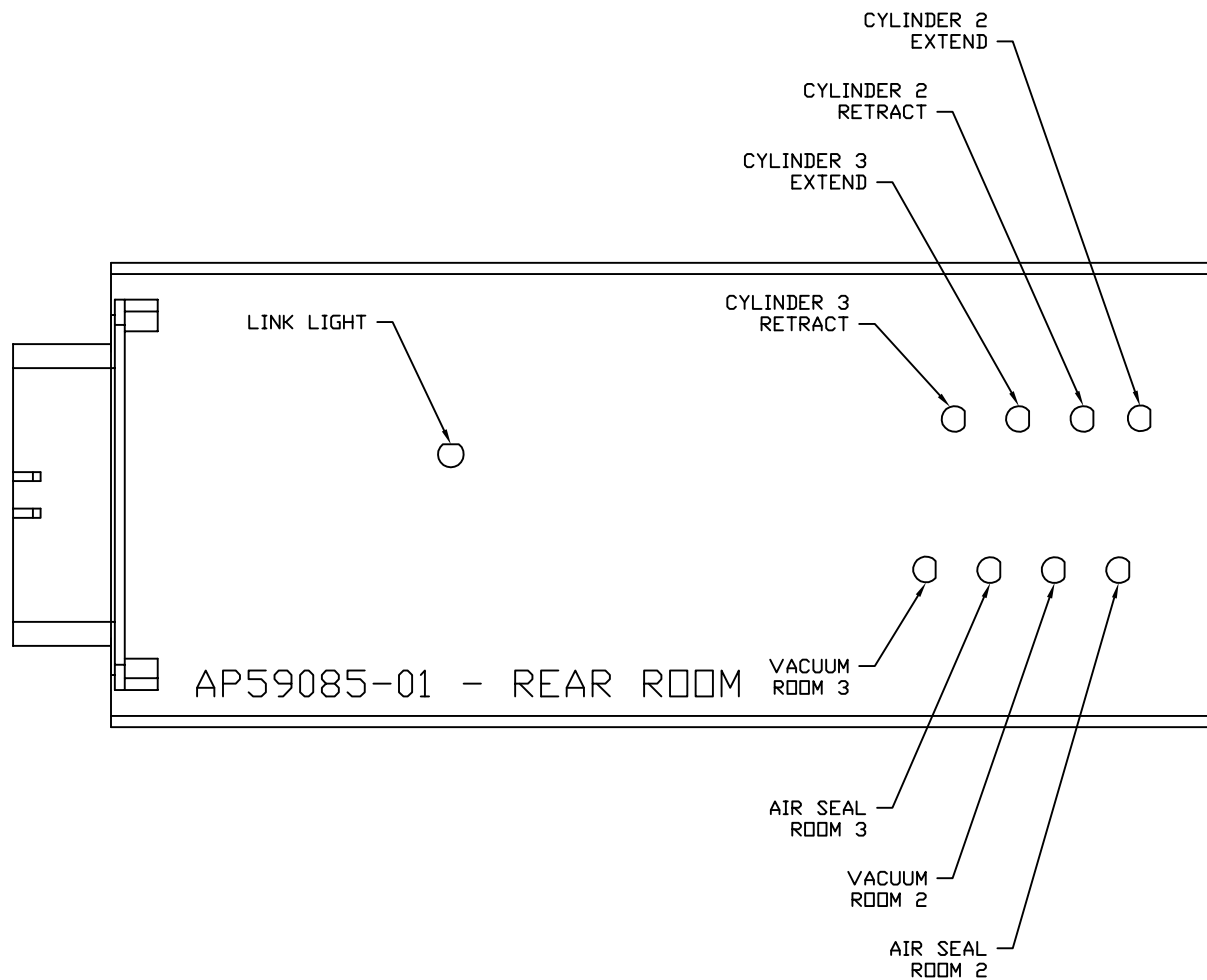

NOTE: INSTALLATION MUST CONFORM TO GOOD SHOP PRACTICES, SAE STANDARDS, RVIA STANDARDS, AND OTHER APPLICABLE STANDARDS.

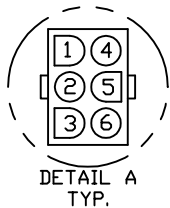

- PIN
- 1. N/C
  - 2. N/C
  - 3. N/C
  - 4. N/C
  - 5. BLK(W7699) WARNING LED/ALARM CONTROL
  - 6. N/C

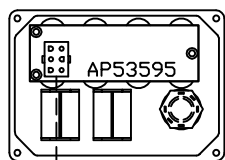
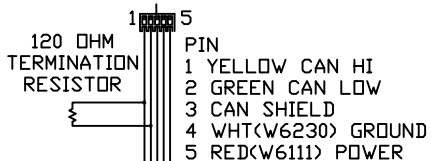
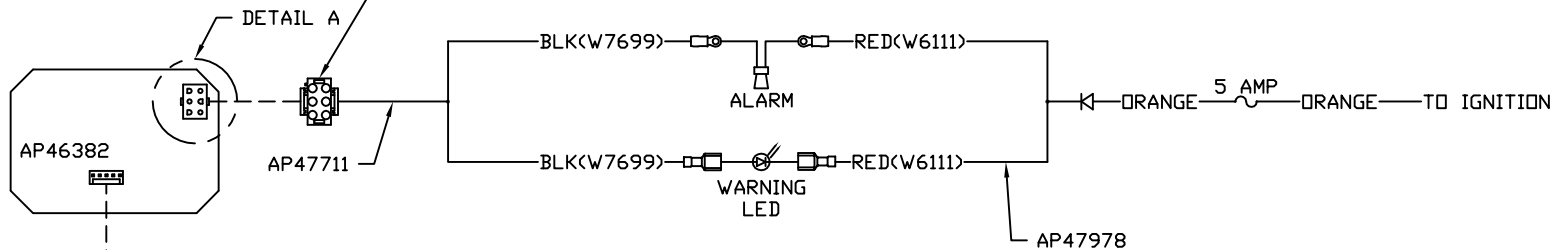

- PIN
- 1 RED(W6805) SW. BATTERY
  - 2 WHT(W6230) GROUND
  - 3 CAN SHIELD
  - 4 GREEN CAN LOW
  - 5 YELLOW CAN HI
  - 6 BLK(W7696) SYSTEM WAKE UP

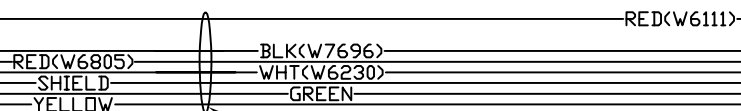

NOTE: INSTALLATION MUST CONFORM TO GOOD SHOP PRACTICES, SAE STANDARDS, RVIA STANDARDS, AND OTHER APPLICABLE STANDARDS.

AP59922

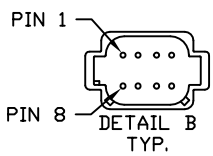
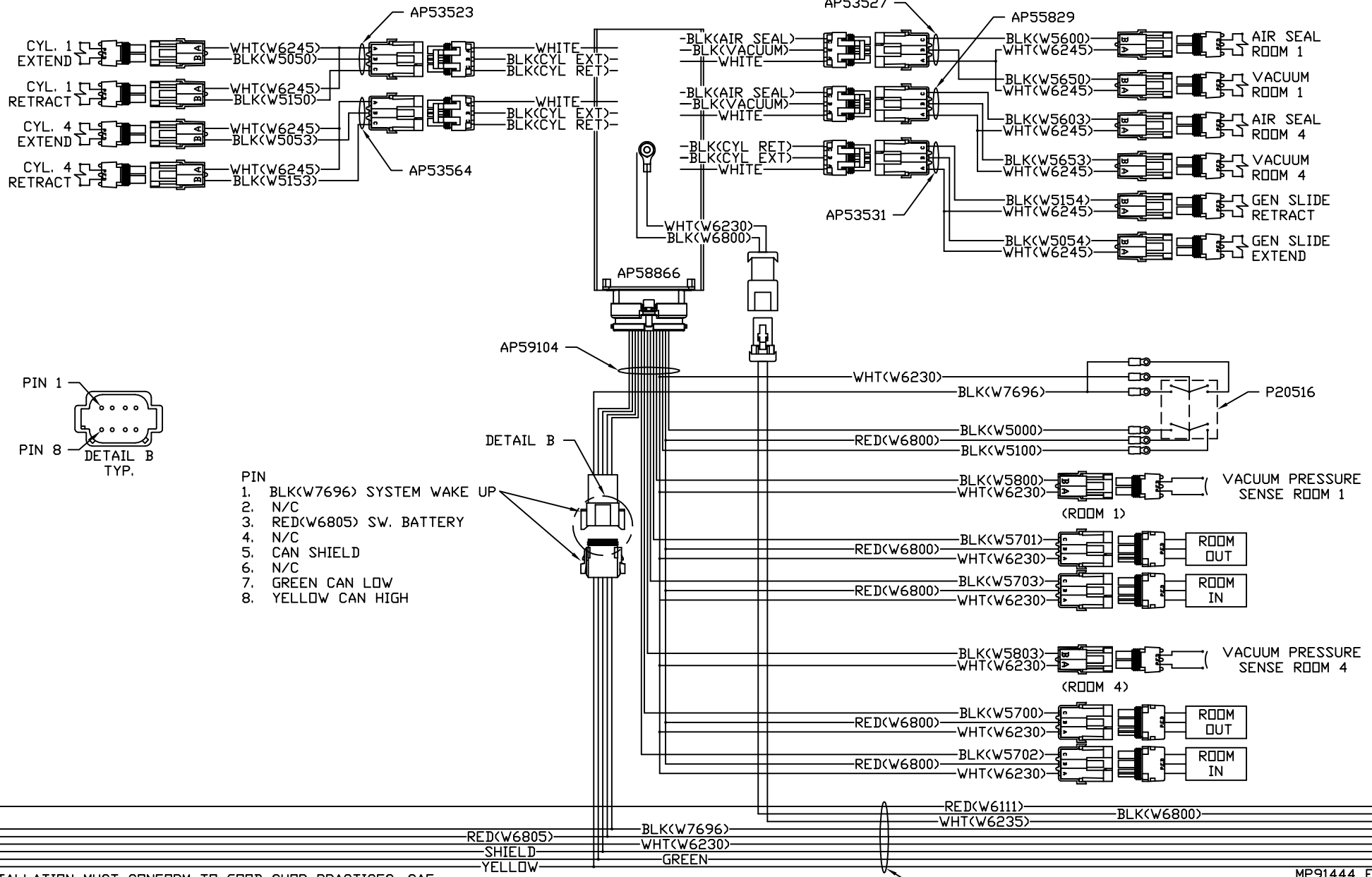

- PIN
1. BLK(W7696) SYSTEM WAKE UP
  2. N/C
  3. RED(W6805) SW. BATTERY
  4. N/C
  5. CAN SHIELD
  6. N/C
  7. GREEN CAN LOW
  8. YELLOW CAN HIGH

NOTE: INSTALLATION MUST CONFORM TO GOOD SHOP PRACTICES, SAE STANDARDS, RVIA STANDARDS, AND OTHER APPLICABLE STANDARDS.

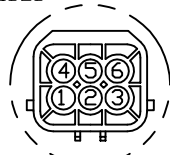
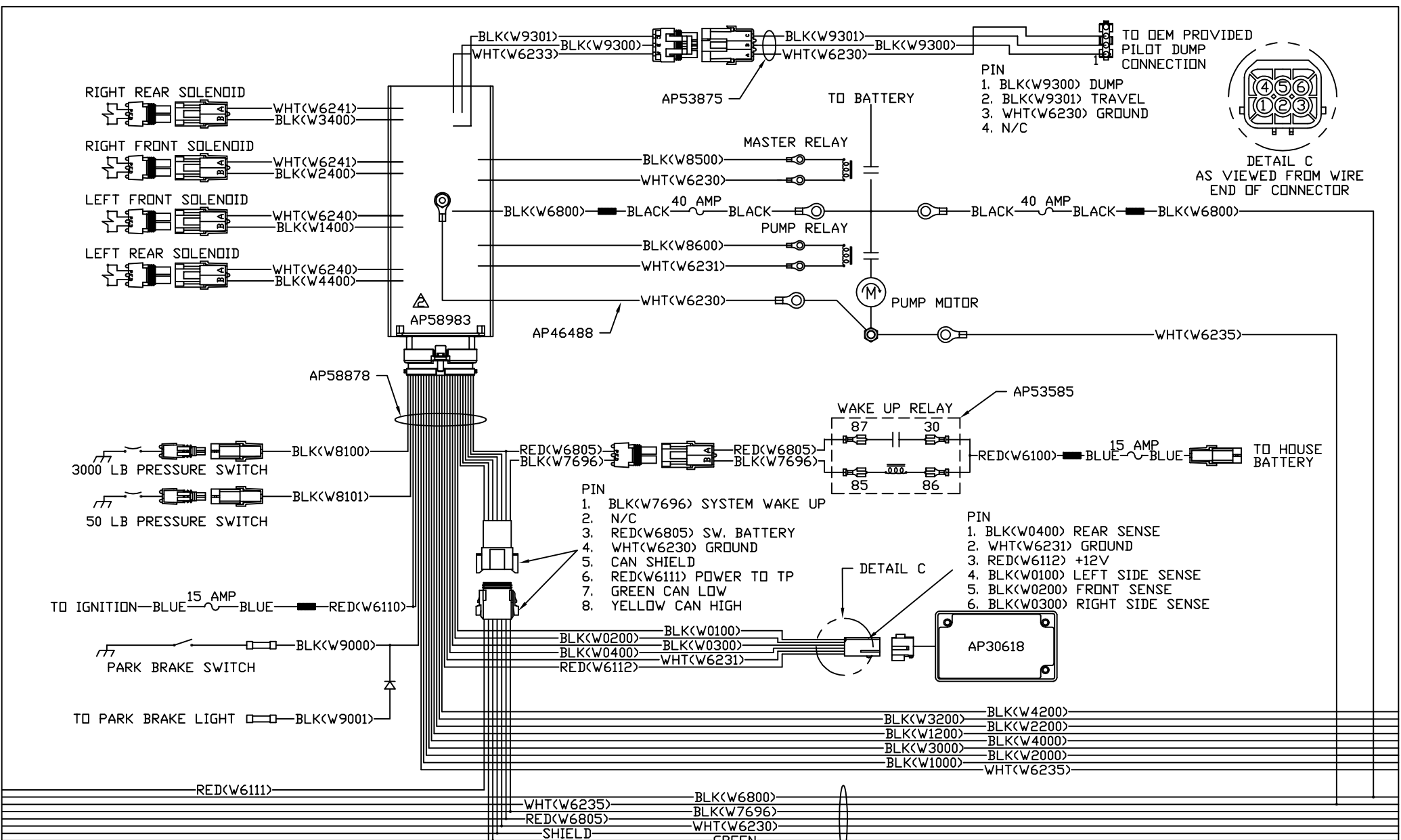

DETAIL C  
AS VIEWED FROM WIRE  
END OF CONNECTOR

- PIN
1. BLK(W9300) DUMP
  2. BLK(W9301) TRAVEL
  3. WHT(W6230) GROUND
  4. N/C

- PIN
1. BLK(W7696) SYSTEM WAKE UP
  2. N/C
  3. RED(W6805) SW. BATTERY
  4. WHT(W6230) GROUND
  5. CAN SHIELD
  6. RED(W6111) POWER TO TP
  7. GREEN CAN LOW
  8. YELLOW CAN HIGH

- PIN
1. BLK(W0400) REAR SENSE
  2. WHT(W6231) GROUND
  3. RED(W6112) +12V
  4. BLK(W0100) LEFT SIDE SENSE
  5. BLK(W0200) FRONT SENSE
  6. BLK(W0300) RIGHT SIDE SENSE

NOTE: INSTALLATION MUST CONFORM TO GOOD SHOP PRACTICES, SAE STANDARDS, RVIA STANDARDS, AND OTHER APPLICABLE STANDARDS.

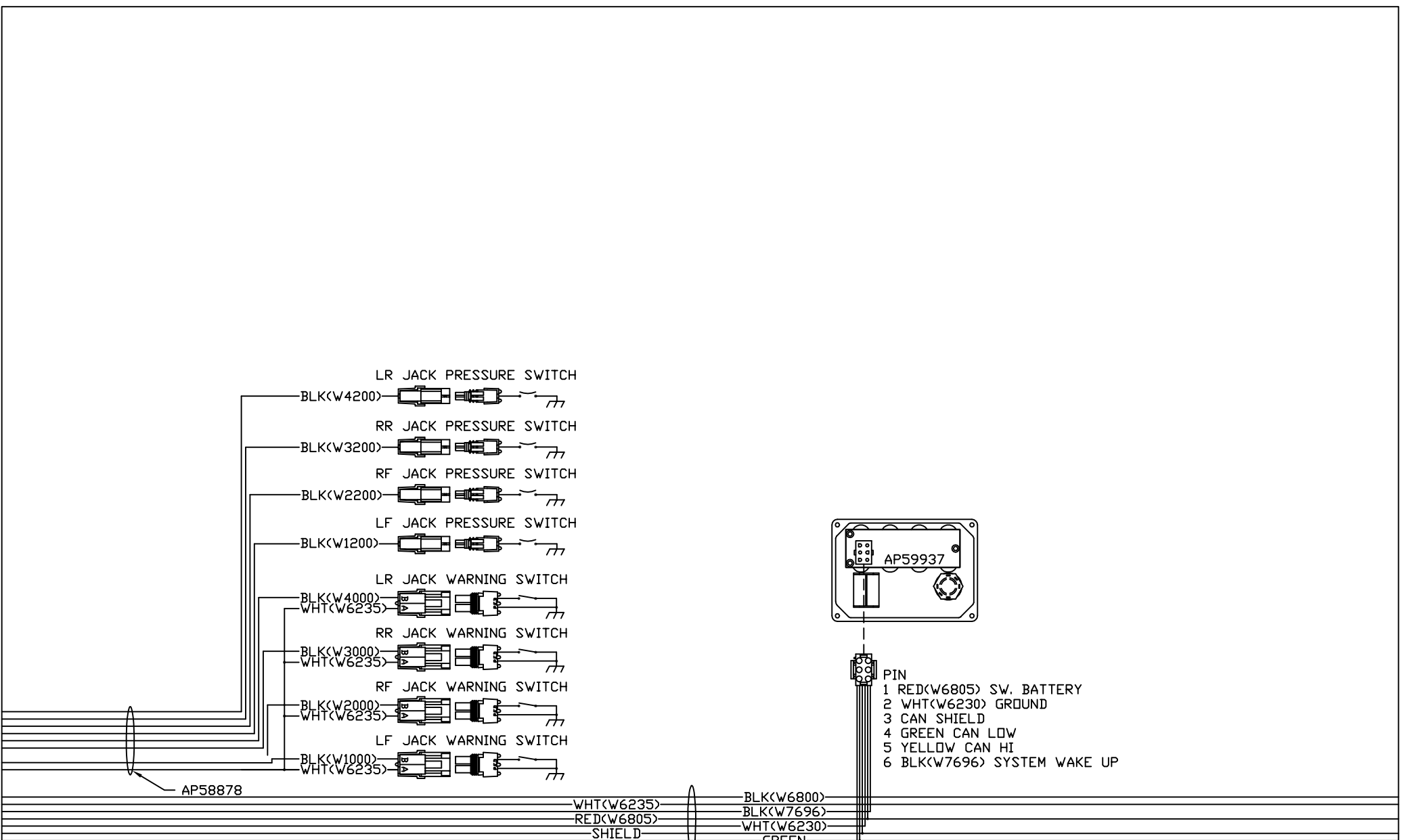

NOTE: INSTALLATION MUST CONFORM TO GOOD SHOP PRACTICES, SAE STANDARDS, RVIA STANDARDS, AND OTHER APPLICABLE STANDARDS.

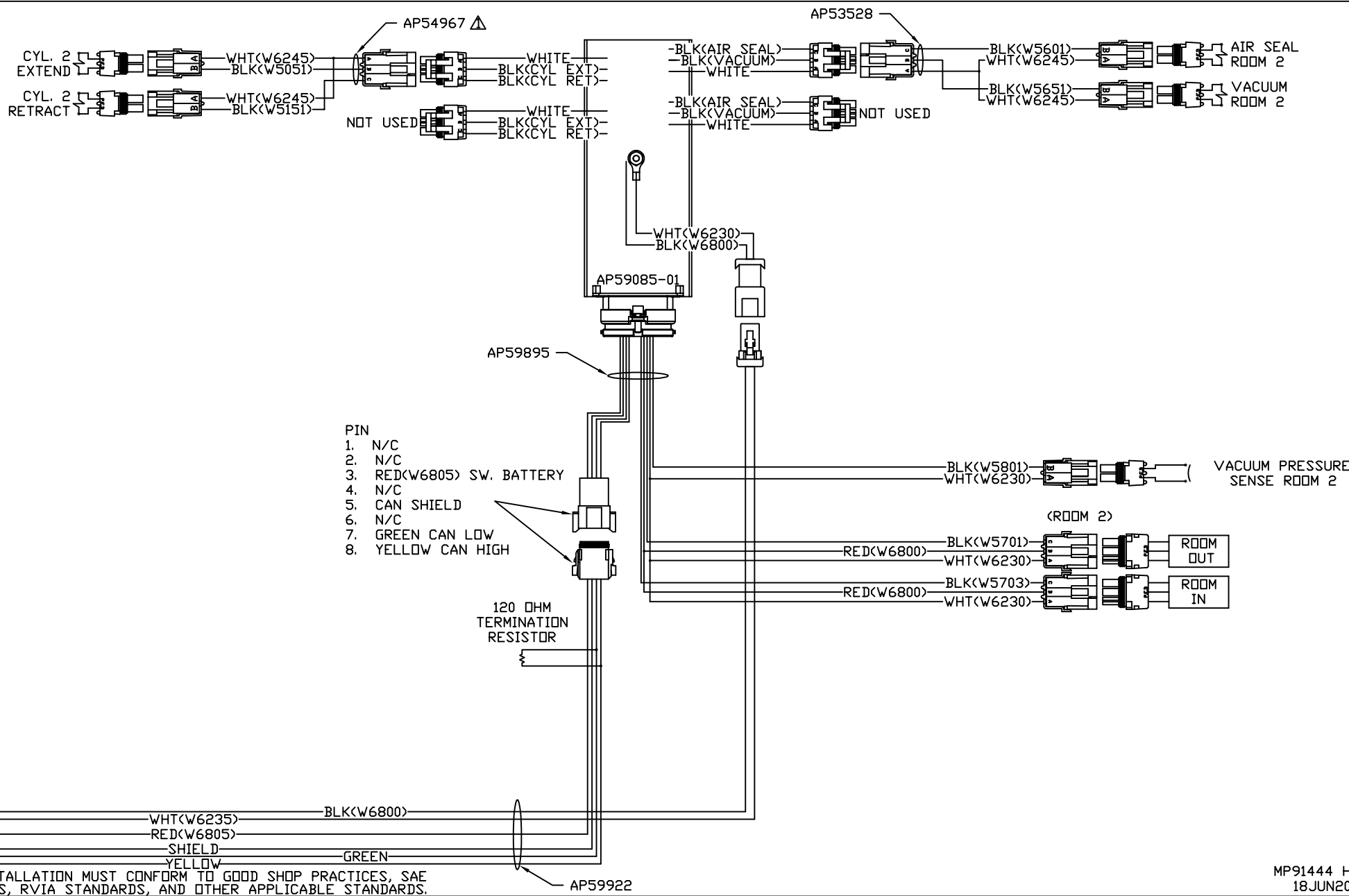

- PIN
1. N/C
  2. N/C
  3. RED(W6805) SW. BATTERY
  4. N/C
  5. CAN SHIELD
  6. N/C
  7. GREEN CAN LOW
  8. YELLOW CAN HIGH

NOTE: INSTALLATION MUST CONFORM TO GOOD SHOP PRACTICES, SAE STANDARDS, RVIA STANDARDS, AND OTHER APPLICABLE STANDARDS.