

ORIENTATION
 ← FRONT

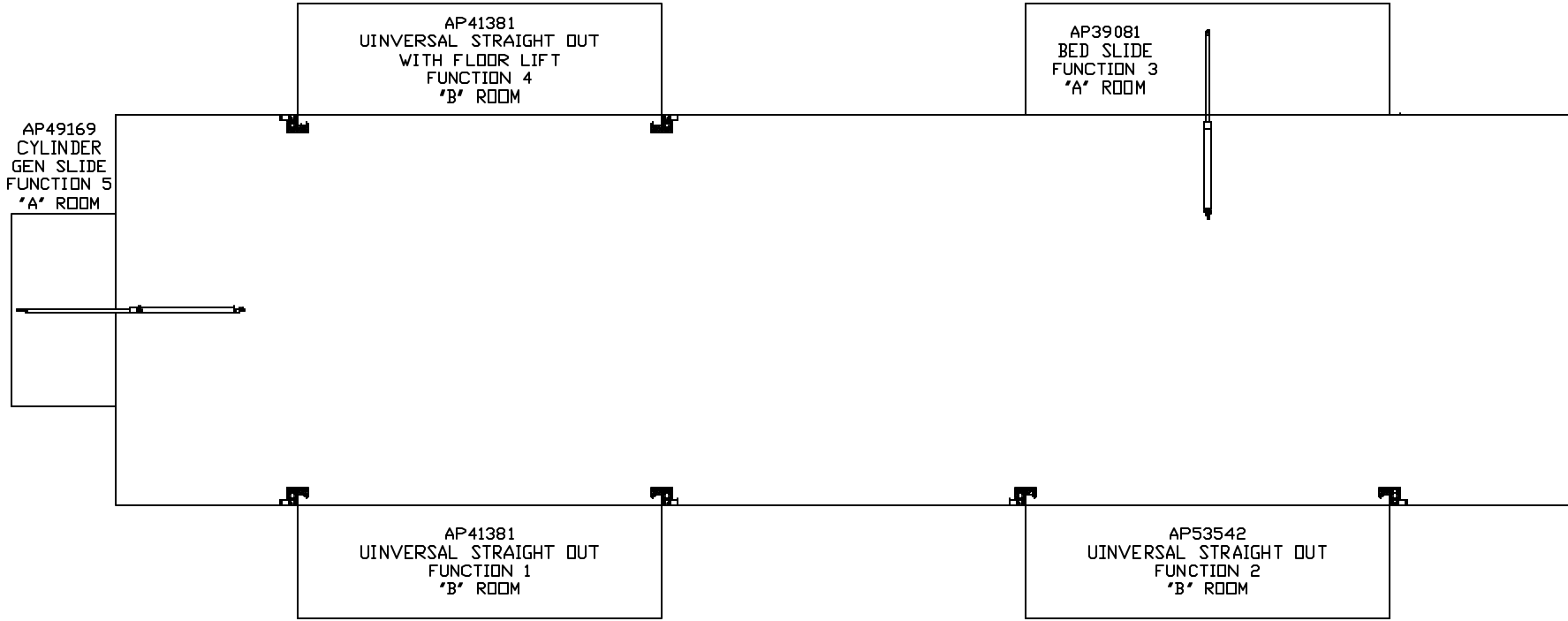

NOTE: INSTALLATION MUST CONFORM TO GOOD SHOP PRACTICES, SAE STANDARDS, RVIA STANDARDS, AND OTHER APPLICABLE STANDARDS.

LEVELING SYSTEM: AP55785

		HWH		I-80 EXIT 267 SOUTH	
				RT 1 MOSCOW, IOWA 52760	
		SCALE 1:6	DATE 09DEC15	DRAWN BY .	
		HYD CONN DIAGRAM			
NO.	DATE	REVISION			
		FORETRAVEL			DRAWING NUMBER
					MP70954 A/F
THE INFORMATION DISCLOSED ON THIS DRAWING IS CONFIDENTIAL AND MUST NOT BE DISCLOSED OR USED IN ANY MANNER WHICH WILL BE DETRIMENTAL TO THE HWH CORPORATION					

NOTE: HOSES (E) AND (F) ARE INCLUDED WITH THE ROOM EXTENSION MECHANISM

(A) HOSE ASSY 04
PRESSURE

(B) .375" TUBING
RETURN

(C) HOSE ASSY 03
ROD END - ALWAYS PRESSURIZED - MUST
MAINTAIN EQUAL LENGTH AND DIAMETER

(D) HOSE ASSY 03
CAP END - MUST MAINTAIN EQUAL LENGTH
AND DIAMETER

(E) AP24632 HOSE ASSY 02 HP x 48"
ROD END - ALWAYS PRESSURIZED - MUST
MAINTAIN EQUAL LENGTH AND DIAMETER

(F) AP24818 HOSE ASSY 02 HP x 86"
CAP END - MUST MAINTAIN EQUAL LENGTH
AND DIAMETER

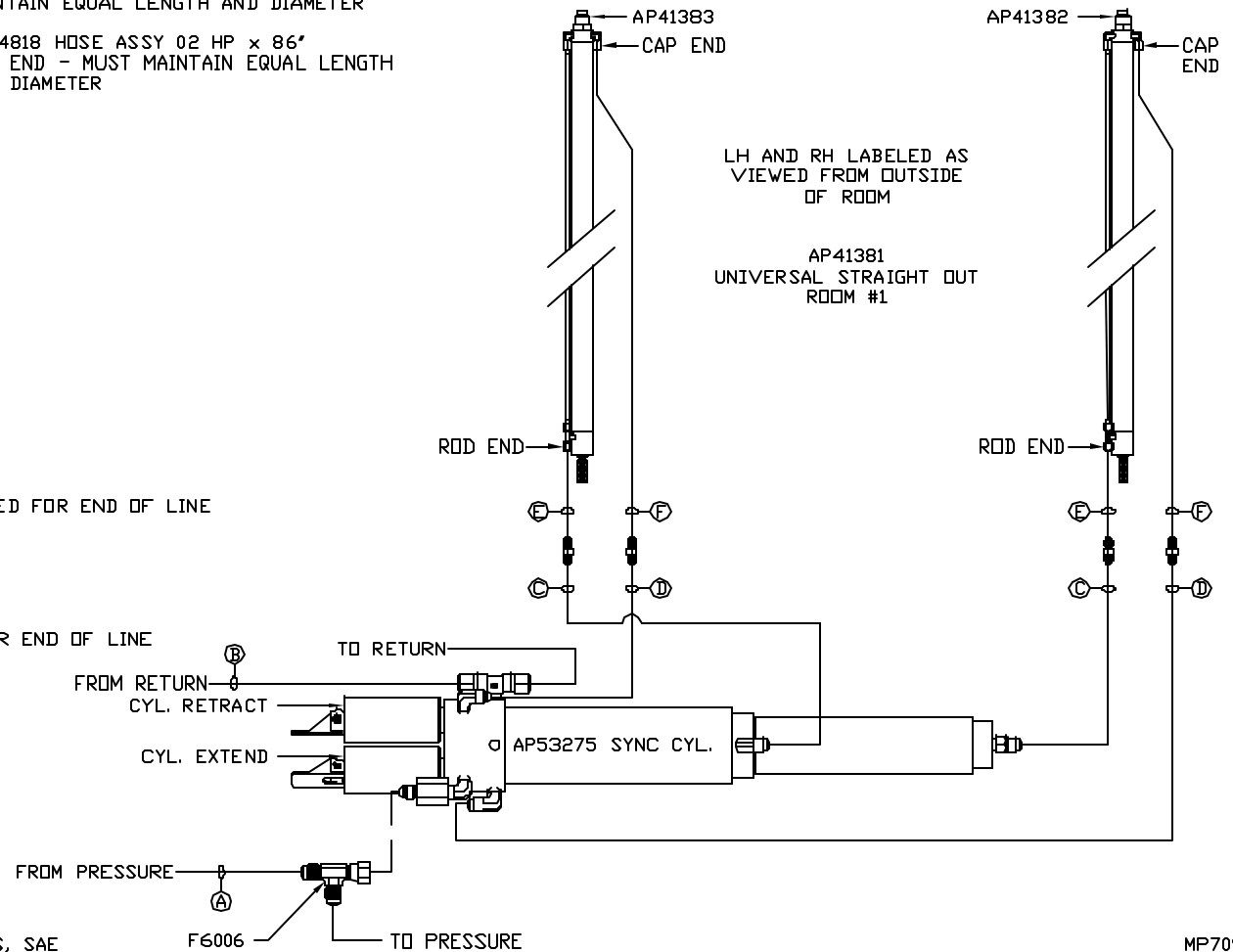
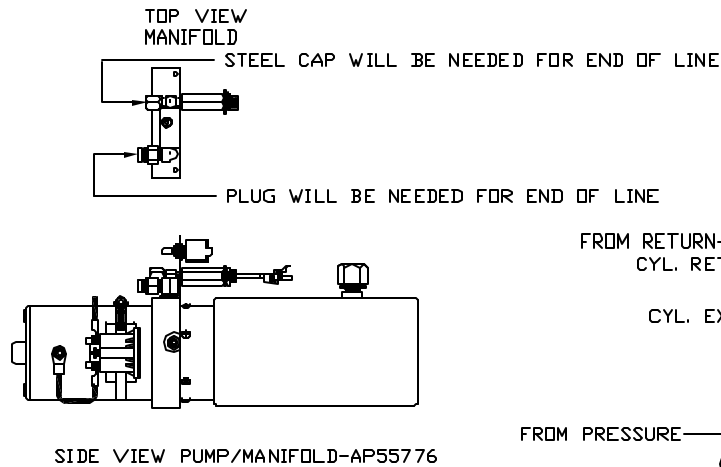

NOTE: INSTALLATION MUST CONFORM TO GOOD SHOP PRACTICES, SAE STANDARDS, RVIA STANDARDS, AND OTHER APPLICABLE STANDARDS.

MP70954 B/F
09DEC15

NOTE: HOSES (C) AND (F) ARE INCLUDED WITH THE ROOM EXTENSION MECHANISM

(A) HOSE ASSY 04
PRESSURE

(B) .375" TUBING
RETURN

(C) HOSE ASSY 03
ROD END - ALWAYS PRESSURIZED - MUST
MAINTAIN EQUAL LENGTH AND DIAMETER

(D) HOSE ASSY 03
CAP END - MUST MAINTAIN EQUAL LENGTH
AND DIAMETER

(E) AP24631 HOSE ASSY 02 HP x 42"
ROD END - ALWAYS PRESSURIZED - MUST
MAINTAIN EQUAL LENGTH AND DIAMETER

(F) AP24637 HOSE ASSY 02 HP x 66"
CAP END - MUST MAINTAIN EQUAL LENGTH
AND DIAMETER

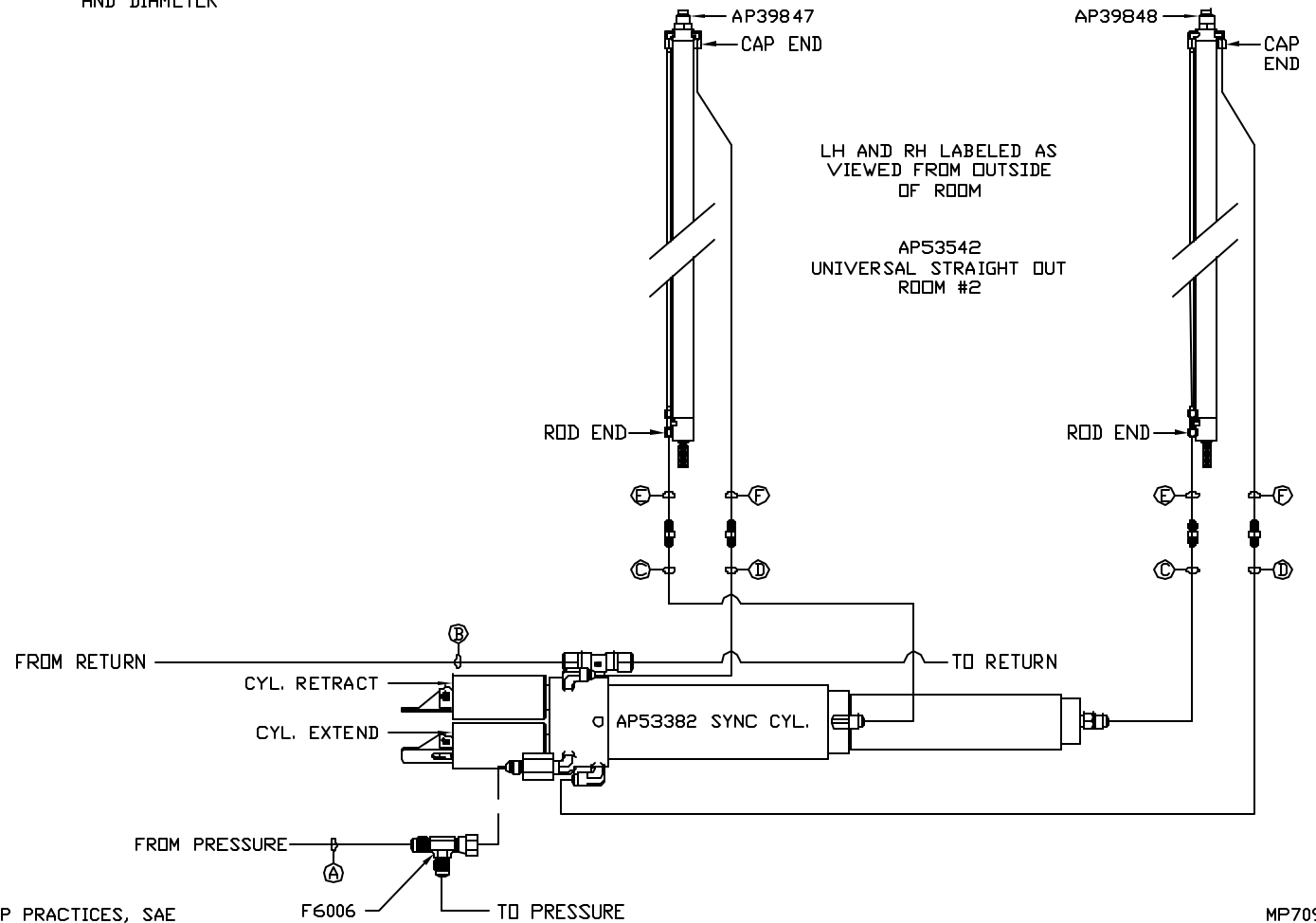

NOTE: INSTALLATION MUST CONFORM TO GOOD SHOP PRACTICES, SAE STANDARDS, RVIA STANDARDS, AND OTHER APPLICABLE STANDARDS.

MP70954 C/F
09DEC15

NOTE: HOSES Ⓔ, Ⓕ AND Ⓖ ARE INCLUDED WITH THE ROOM EXTENSION MECHANISM

- Ⓐ HOSE ASSY 04
PRESSURE
- Ⓑ .375" TUBING
RETURN
- Ⓒ HOSE ASSY 03
ROD END - ALWAYS PRESSURIZED
- Ⓓ HOSE ASSY 03
CAP END
- Ⓔ AP24632 HOSE ASSY 02 HP x 48"
ROD END - ALWAYS PRESSURIZED
- Ⓕ AP24628 HOSE ASSY 02 HP x 24.25"
CAP END
- Ⓖ AP25677 HOSE ASSY 02 HP x 20"
CAP END

ROOM #3
AP39081
BED SLIDE KIT

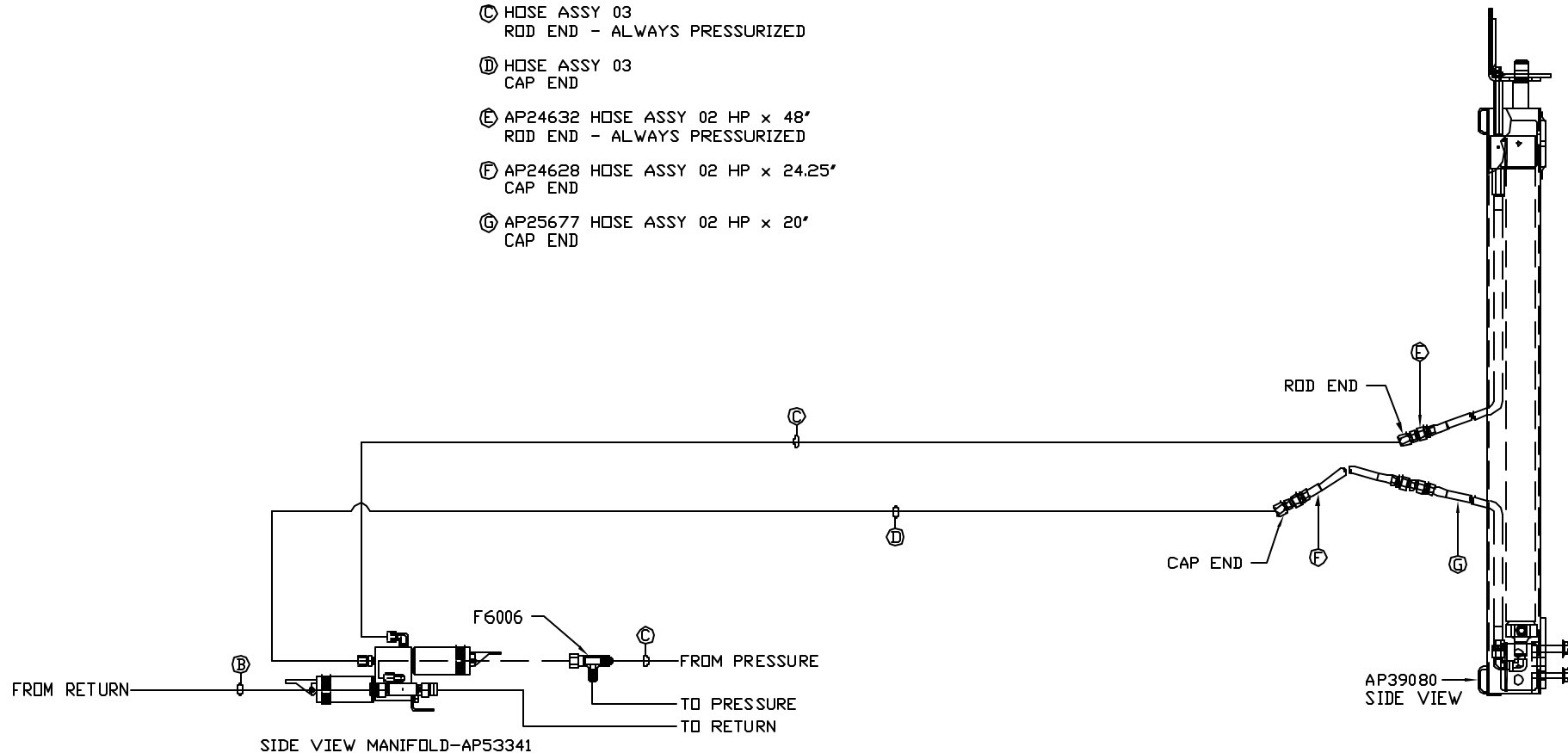

NOTE: INSTALLATION MUST CONFORM TO GOOD SHOP PRACTICES, SAE STANDARDS, RVIA STANDARDS, AND OTHER APPLICABLE STANDARDS.

MP70954 D/F
09DEC15

- Ⓐ HOSE ASSY 04
PRESSURE
- Ⓑ .375" ID NYLON TUBING
RETURN
- Ⓒ HOSE ASSY 03
ROD END - ALWAYS PRESSURIZED - MUST
MAINTAIN EQUAL LENGTH AND DIAMETER
- Ⓓ HOSE ASSY 03
CAP END - MUST MAINTAIN EQUAL LENGTH
AND DIAMETER
- Ⓔ AP24632 HOSE ASSY 02 HP x 48"
ROD END - ALWAYS PRESSURIZED - MUST
MAINTAIN EQUAL LENGTH AND DIAMETER
- Ⓕ AP24818 HOSE ASSY 02 HP x 86"
CAP END - MUST MAINTAIN EQUAL LENGTH
AND DIAMETER
- Ⓖ AP4218 HOSE ASSY 04 x 40"
CAP END (LIFT)
- Ⓗ AP4062 HOSE ASSY 04 x 132"
CAP END (LIFT)
- Ⓚ AP5350 HOSE ASSY 04 x 57"
CAP END (ROOM)
- Ⓛ AP4073 HOSE ASSY 04 x 60"
ROD END (LIFT) - ALWAYS
PRESSURIZED
- Ⓜ AP7177 HOSE ASSY 04 x 70"
CAP END (LIFT)
- Ⓝ AP4075 HOSE ASSY 04 x 42"
ROD END - ALWAYS PRESSURIZED (LIFT)

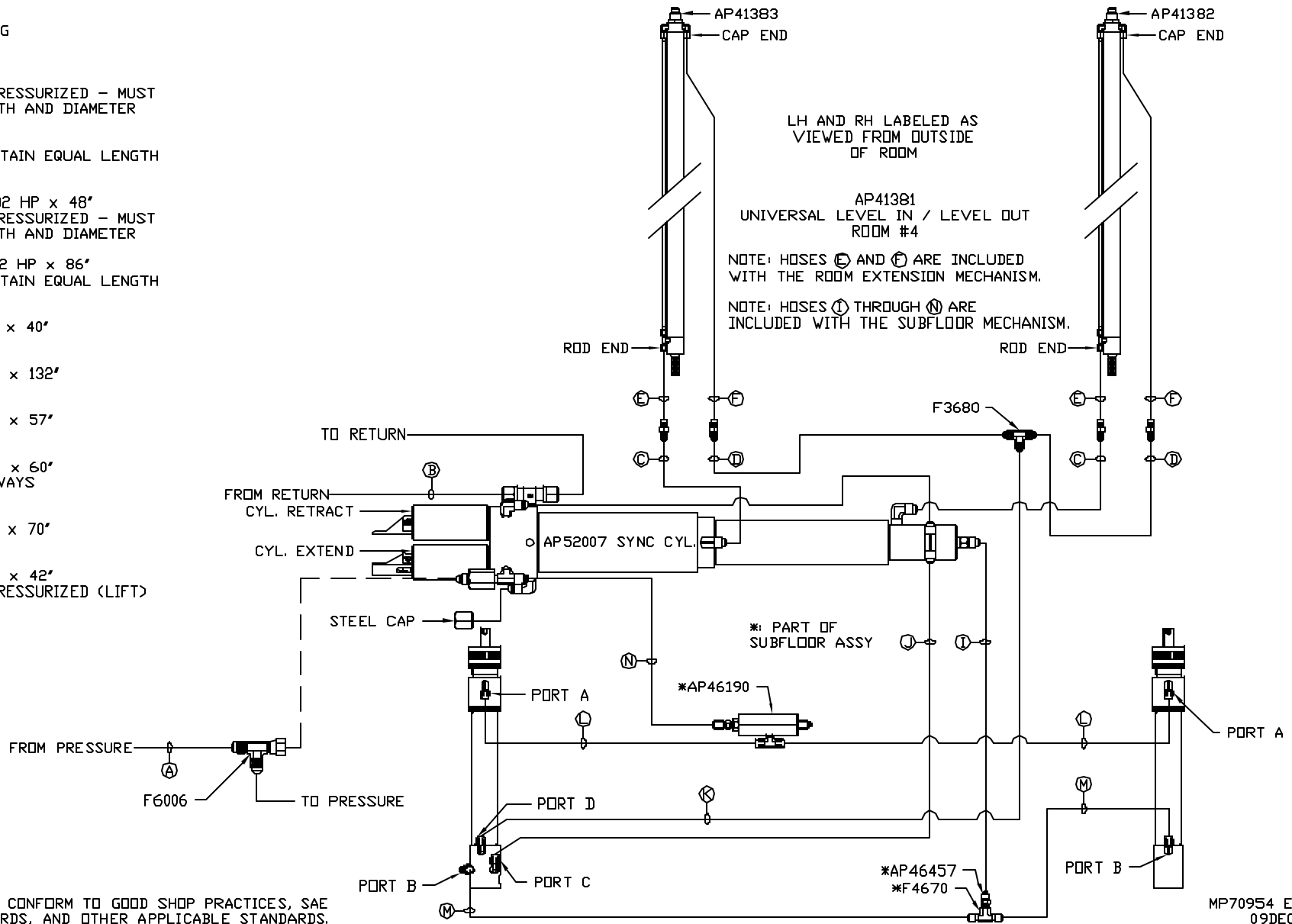

NOTE: INSTALLATION MUST CONFORM TO GOOD SHOP PRACTICES, SAE STANDARDS, RVIA STANDARDS, AND OTHER APPLICABLE STANDARDS.

- Ⓐ HOSE ASSY 03
CAP END
- Ⓑ HOSE ASSY 03
ROD END - ALWAYS PRESSURIZED
- Ⓒ HOSE ASSY 04
PRESSURE
- Ⓓ .375" TUBING
RETURN

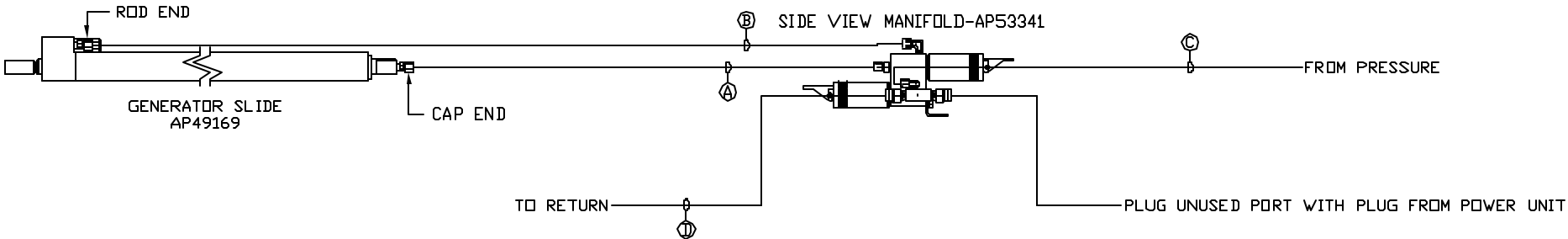

NOTE: INSTALLATION MUST CONFORM TO GOOD SHOP PRACTICES, SAE STANDARDS, RVIA STANDARDS, AND OTHER APPLICABLE STANDARDS.

MP70954 F/F
09DEC15