

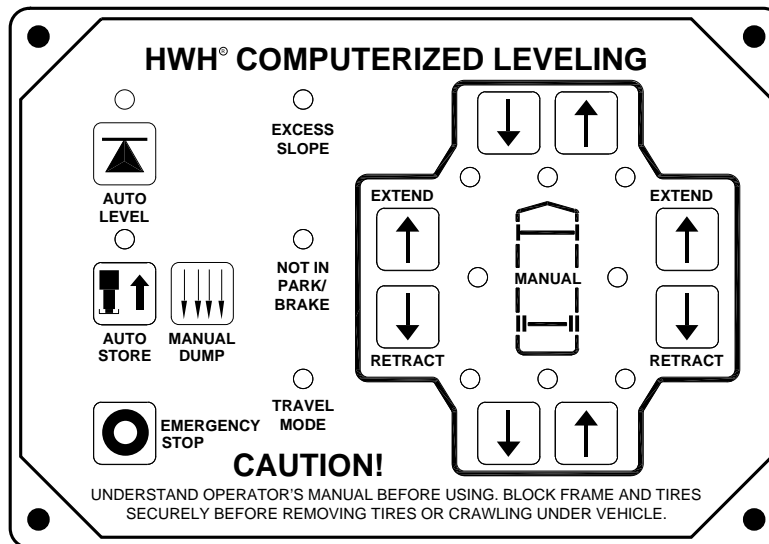

# OPERATOR'S MANUAL

## HWH® COMPUTER-CONTROLLED 625 SERIES LEVELING SYSTEM

**FEATURING:**  
*Touch Panel Leveling Control*  
*BI-AXIS® Hydraulic Leveling*  
*Straight-Acting Jacks*  
*(With Dump)*



**HWH CORPORATION**  
(On I-80, Exit 267 South)  
2096 Moscow Road | Moscow, Iowa 52760  
Ph: 800/321-3494 (or) 563/724-3396 | Fax: 563/724-3408  
[www.hwh.com](http://www.hwh.com)

---

# OPERATOR'S MANUAL

---

## CAUTION !

READ THE ENTIRE OPERATOR MANUAL BEFORE OPERATING.

BLOCK FRAME AND TIRES SECURELY BEFORE CRAWLING UNDER VEHICLE. DO NOT USE LEVELING JACKS OR AIR SUSPENSION TO SUPPORT VEHICLE WHILE UNDER VEHICLE OR CHANGING TIRES. VEHICLE MAY DROP AND/OR MOVE FORWARD OR BACKWARD WITHOUT WARNING CAUSING INJURY OR DEATH.

KEEP ALL PEOPLE CLEAR OF VEHICLE WHILE OPERATING LEVELING SYSTEM OR ROOM EXTENSIONS.

KEEP ALL PEOPLE CLEAR OF VEHICLE WHILE DUMPING AIR FROM THE VEHICLE'S SUSPENSION.

DO NOT MOVE THE VEHICLE IF THE VEHICLE IS NOT AT THE PROPER RIDE HEIGHT. CONTACT MANUFACTURER TECHNICAL SERVICE FOR MOVING THE VEHICLE WHEN NOT AT THE PROPER RIDE HEIGHT.

WEAR SAFETY GLASSES WHEN INSPECTING OR SERVICING THE SYSTEM TO PROTECT EYES FROM DIRT, METAL CHIPS, OIL LEAKS, ETC. FOLLOW ALL OTHER APPLICABLE SHOP SAFETY PRACTICES.

IMPORTANT: IF COACH IS EQUIPPED WITH A ROOM EXTENSION, READ ROOM EXTENSION SECTION BEFORE OPERATING LEVELING SYSTEM.

## HOW TO OBTAIN WARRANTY SERVICE

### THIS IS NOT TO BE INTERPRETED AS A STATEMENT OF WARRANTY

HWH CORPORATION strives to maintain the highest level of customer satisfaction. Therefore, if you discover a defect or problem, please do the following:

**FIRST:** Notify the dealership where you purchased the vehicle or had the leveling system installed. Dealership management people are in the best position to resolve the problem quickly. If the dealer has difficulty solving the problem, he should immediately contact the Customer Service Department, at HWH CORPORATION.

**SECOND:** If your dealer cannot or will not solve the problem, notify the Customer Service Department:  
HWH CORPORATION 2096 Moscow Rd. Moscow IA. 52760  
(563) 724-3396 OR (800) 321-3494. Give your name and address, coach manufacturer and model year, date the coach was purchased, or the date of system installation,

description of the problem, and where you can be reached during business hours (8:00 a.m. till 5:00 p.m. c.s.t.). HWH CORPORATION personnel will contact you to determine whether or not your claim is valid. If it is, HWH CORPORATION will authorize repair or replacement of the defective part, either by appointment at the factory or by the authorization of an independent service facility, to be determined by HWH CORPORATION. All warranty repairs must be performed by an independent service facility authorized by HWH CORPORATION, or at the HWH CORPORATION factory, unless prior written approval has been obtained from proper HWH CORPORATION personnel.

# CONTROL IDENTIFICATION

## 625 SERIES LEVELING SYSTEM

### COMPUTER-CONTROL

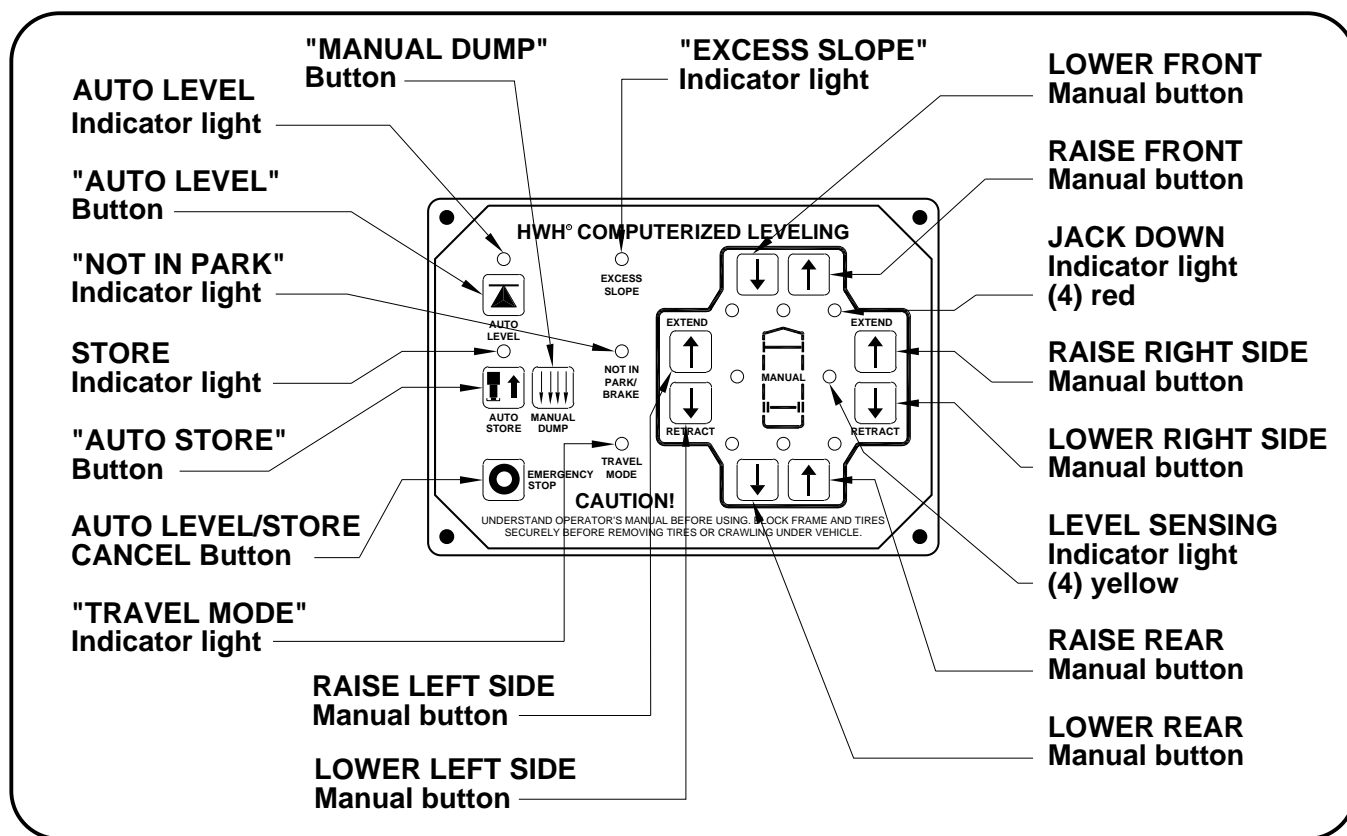

## CONTROL FUNCTIONS

### CONTROL BUTTONS

**"EMERGENCY STOP" BUTTON:** Push this button to stop any leveling system operation.

**"AUTO LEVEL" BUTTON:** Push this button any time to start the automatic leveling function.

**"AUTO STORE" BUTTON:** Push this button to retract all four jacks at the same time.

**"MANUAL DUMP" BUTTON:** This is a manual button for dumping air from the vehicle suspension.

**EXTEND BUTTONS (UP ARROWS):** These buttons will extend their respective jack pairs to lift the vehicle.

**RETRACT BUTTONS (DOWN ARROWS):** These buttons will retract their respective jack pairs to lower the vehicle.

### INDICATOR LIGHTS

**AUTO LEVEL INDICATOR LIGHT:** This light will flash during the automatic leveling function.

**STORE INDICATOR LIGHT:** This light will flash during the automatic store function.

**"NOT IN PARK/BRAKE" LIGHT:** This indicator will light when the hand/auto brake is not set and the "AUTO LEVEL" button is being pushed.

### INDICATOR LIGHTS (CONTINUED)

**LEVELING LIGHTS:** The four yellow indicating lights are level sensing indicators. When a yellow light is on, it indicates that its side, end, or corner of the vehicle is low. No more than two lights should be on at the same time. When all four yellow LEVEL lights are out, the vehicle is level. SEE OPERATOR'S PROCEDURES - AUTOMATIC HYDRAULIC LEVELING FOR DETAILED EXPLANATION.

**WARNING LIGHTS:** The four red lights surrounding the yellow level indicators are jacks down WARNING lights. They are functional only when the ignition is in the "ON" or "ACC" position, the system is on, and the jacks are extended 1/4 to 1/2 inch.

**"EXCESS SLOPE" LIGHT:** This indicator will light when the leveling system cannot level the vehicle.

**"TRAVEL MODE" LIGHT:** This indicator light will be on when the ignition is on, when the jacks are retracted and there are no red WARNING lights on.

**MASTER "JACKS DOWN" WARNING LIGHT:** This is a light mounted in the dash separate from the touch panel. It will be on when any one or more jacks are extended and the ignition is "ON".

**BUZZER:** This is a jacks down warning. It will sound if the master "JACKS DOWN" warning light is on.

---

# CONTROL IDENTIFICATION

## PUMP RUN TIME

---

### PUMP RUN TIME

Pump motors used with HWH leveling systems and room extension systems come in 3 different diameters; 3", 3.7" and 4.5". Contact the vehicle manufacturer or HWH for help with identifying the motor size. **It is important that any time the pump runs for more than four minutes with a 3" motor; or six minutes with a 3.7" or 4.5" motor that the motor is allowed to cool for thirty minutes before continuing. Continuous operation of the pump motor without allowing the motor to cool can damage the motor.** For cold weather information see "COLD WEATHER OPERATIONS" below.

The HWH systems with a computer processor monitor the pump run time and will turn the pump off if the run time exceeds a specified time. This time can vary with different systems. Due to available electronics or system design, the pump run time programs will also vary. Leveling systems and room extensions that are not controlled by a system processor have no pump run time protection. **DO NOT run the pump more than four or six minutes without allowing the pump motor to cool for thirty minutes.**

#### SYSTEM VARIATIONS FOR PUMP RUN TIME

Some systems with rooms run the rooms separate from the system processor. These systems do not monitor pump run time when operating the rooms. **DO NOT run the pump more than four or six minutes without allowing the pump motor to cool for thirty minutes.**

Some systems can be turned back on immediately after the processor turns the pump off. **DO NOT turn the system back on or run the pump without allowing the pump motor to cool for thirty minutes.**

When operating some leveling systems manually or operating the room extensions, the pump will turn off and back on while pushing the control button when the pump run time has been exceeded. **DO NOT continue without allowing the pump motor to cool for thirty minutes.**

With some systems, when the processor has turned the pump off because the run time has been exceeded, power to the HWH system must be turned off and back on before the system will operate. With motorized vehicles, turn the ignition off and back on. With non-motorized vehicles, turn the master power switch for the HWH system off and back on. **DO NOT continue without allowing the pump motor to cool for thirty minutes.**

Some HWH systems are equipped with a lighted reset switch. If the processor turns the pump off because the run time has been exceeded, the light in the reset switch will turn on. The system will not operate until the reset switch is pushed.

**DO NOT continue without allowing the pump motor to cool for thirty minutes.**

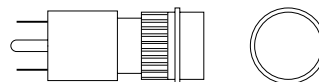

**LIGHTED RESET SWITCH**

**No matter what HWH system is on the vehicle, the pump should not be ran for more than four minutes (3" motors) or six minutes (3.7" or 4.5" motors) without allowing the pump motor to cool for thirty minutes. Continuous operation of the pump motor without allowing the motor to cool can damage the pump motor.**

Contact HWH corporation to get specific information about the system in this vehicle.

## COLD WEATHER OPERATIONS

HWH leveling and room extension systems are designed to function in cold weather down to 0 degrees Fahrenheit. Below freezing (32 degrees Fahrenheit) the jacks or rooms will operate slower than usual.

For operation in temperatures dropping below -20 degrees Fahrenheit, it is necessary that the system is equipped with oil designed for extreme cold weather application such as a synthetic oil. (Contact HWH for recommendations.)

**DO NOT run the pump motor continuously. It is important that any time the pump runs for more than four minutes with a 3" motor; or six minutes with a 3.7" or 4.5" motor that the motor is allowed to cool for thirty minutes before continuing. Continuous operation of the pump motor without allowing the motor to cool can damage the motor.** Continuous operation of the pump with slow moving jacks or rooms in cold weather, without allowing the pump motor to cool will cause the pump motor to burn up and damage the pump assembly.

---

# OPERATING PROCEDURES

---

## GENERAL INSTRUCTIONS

Maintain adequate clearance in all directions for vehicle, room extensions, awnings, doors, steps, etc. Vehicle may move in any direction due to jacks extending or retracting, settling of the jacks or the vehicle, equipment malfunction, etc..

If parking on soft ground or asphalt paving, a wood block or pad should be placed under each jack.

Press the "EMERGENCY STOP" button or turn the ignition switch "OFF" at any time to stop the operation of the system.

Any time a hydraulic leveling process is interrupted, retract the jacks according to the JACK RETRACTION Section and then restart the leveling process.

If the hand / auto brake is not set when the "AUTO LEVEL" button is pressed, the "NOT IN PARK/BRAKE" light will come on. When the "AUTO LEVEL" button is released the "NOT IN PARK/BRAKE" light will go out. The Automatic Leveling function will not start.

**CAUTION: DO NOT MOVE THE VEHICLE IF ONE OR MORE JACKS ARE EXTENDED TO THE GROUND.**

## PREPARATION FOR TRAVEL

**IMPORTANT:** Before traveling, the red jack warning lights must be off the "TRAVEL MODE" light must be on and the vehicle should be at the proper height for travel. If lights are not correct for travel, retract jack as described in the JACK RETRACTION Section.

If the jacks are retracted but a red "WARNING" light is lit the system needs to be serviced.

Any room extension or generator slide should be fully retracted before traveling.

**CAUTION: DO NOT MOVE THE VEHICLE WHILE THE LEVELING JACKS ARE STILL IN CONTACT WITH THE GROUND OR IN THE EXTEND POSITION. THIS VEHICLE IS EQUIPPED WITH STRAIGHT-ACTING JACKS. MOVING THE VEHICLE WITH THE LEVELING JACKS EXTENDED CAN CAUSE SEVERE DAMAGE TO THE JACKS AND OR THE VEHICLE AND CREATE A DRIVING**

**HAZARD. DO NOT RELY SOLELY UPON WARNING LIGHTS. IT IS THE OPERATOR'S RESPONSIBILITY TO CHECK THAT ALL JACKS ARE FULLY RETRACTED INTO THE STORE/TRAVEL POSITION AND THE VEHICLE IS AT THE PROPER RIDE HEIGHT FOR TRAVELING. CONTACT MANUFACTURER TECHNICAL SERVICE BEFORE MOVING A VEHICLE THAT IS NOT AT PROPER TRAVEL HEIGHT.**

If the jacks cannot be retracted according to the JACK RETRACTION Section, retract the jacks according to the MANUAL JACK RETRACTION Section. The system should then be checked.

**NOTE:** If the vehicle is parked or stored with the jacks extended for an extended period of time and the jacks fail to retract completely, extend the jacks back down to the ground then retract the jacks again.

---

# OPERATING PROCEDURES

## 625 SERIES LEVELING SYSTEM

---

### AUTOMATIC HYDRAULIC LEVELING (HWH TOUCH PANEL CONTROLS)

1. Place transmission in the recommended position for parking the vehicle and set parking brake. Turn the coach engine off. Turn the ignition to the "ACCESSORY" position.

**NOTE: One or two yellow level indicator lights on the leveling system touch panel can be on anytime the vehicle ignition is in the ON or ACC. position and the park brake is set.**

2. At this time, the operator may want to check the jacks and place a pad under each jack if the ground will not support the vehicle.

**CAUTION: PRIOR TO PUSHING THE "AUTO LEVEL" BUTTON THE OPERATOR MUST BE SURE THAT ALL PERSONS AND OBJECTS ARE CLEAR OF THE VEHICLE. AIR WILL BE EXHAUSTED FROM THE VEHICLE SUSPENSION AND THE VEHICLE WILL LOWER IMMEDIATELY AFTER THE "AUTO LEVEL" BUTTON IS PUSHED.**

3. Press the "AUTO LEVEL" button one time. The AUTO LEVEL light will start to flash. The system will begin to dump air from the vehicle suspension. After approximately 25 seconds, the leveling process will begin.

AUTO LEVEL SEQUENCE: During the automatic leveling sequence, after the system has extended the appropriate jacks to level the vehicle and has turned the yellow level indicator lights off, the system will then stabilize the vehicle. While the system is stabilizing the vehicle, the yellow level indicator lights are inhibited from coming on. Stabilizing the vehicle is accomplished by extending any jacks to the ground that were not used to level the vehicle. This is done by monitoring a pressure switch on each jack. Any jack used to stabilize the vehicle will lift the vehicle approximately one (1) inch. This "bumps" the vehicle up slightly when stabilizing. Due to the ½ degree accuracy tolerance of the sensing unit, one or two yellow level indicator lights may come on after the red auto level indicator light turns off.

The slight lift experienced during the stabilizing procedure normally is not sufficient to cause a level issue for the motor home. However, a feature of the single step leveling system is the manual leveling buttons will function anytime the ignition is in the ON or ACC. position and the park brake is set. If desired, the operator can use the UP ARROWS (extend jacks) that correspond to any lit yellow level indicator light to "bump" the vehicle up slightly to turn that yellow indicator light off.

**IMPORTANT: During the Automatic Leveling procedures, pushing the "AUTO LEVEL", "AUTO STORE" or the "EMERGENCY STOP" button on the HWH touch panel will stop the automatic leveling function.**

EXCESS SLOPE SITUATION: In the event the jacks are unable to level the coach, the "EXCESS SLOPE" light will come on. Excess slope is two jacks fully extending without turning the yellow level light out. The system will not stabilize the vehicle if the "EXCESS SLOPE" light comes on. One or more jacks may not be extended. The system will shut off leaving the "EXCESS SLOPE" light on. The "EXCESS SLOPE" light will remain on if the ignition is in the "ON" or "ACC" position, until the jacks have been fully retracted turning the red warning lights out. Push the "STORE" button to retract the jacks. Move the vehicle to a more level position or level the vehicle as close as possible according to the MANUAL HYDRAULIC OPERATION section.

5. Turn the ignition switch to the "OFF" position.

---

# OPERATING PROCEDURES

## 625 SERIES LEVELING SYSTEM

---

### JACK RETRACTION (HWH TOUCH PANEL CONTROLS)

**CAUTION:** THE OPERATOR MUST BE SURE THAT THERE ARE NO OBJECTS UNDER THE VEHICLE AND THAT ALL PEOPLE ARE CLEAR OF THE VEHICLE.

**CAUTION:** DO NOT MOVE THE VEHICLE WHILE THE LEVELING JACKS ARE STILL IN CONTACT WITH THE GROUND OR IN THE EXTEND POSITION. THIS VEHICLE IS EQUIPPED WITH STRAIGHT-ACTING JACKS. MOVING THE VEHICLE WITH THE LEVELING JACKS EXTENDED CAN CAUSE SEVERE DAMAGE TO THE JACKS AND OR THE VEHICLE AND CREATE A DRIVING HAZARD. DO NOT RELY SOLELY UPON WARNING LIGHTS. IT IS THE OPERATOR'S RESPONSIBILITY TO CHECK THAT ALL JACKS ARE FULLY RETRACTED INTO THE STORE/TRAVEL POSITION AND THE VEHICLE IS AT THE PROPER RIDE HEIGHT.

1. Start the engine. Press the "STORE" button immediately.

The store indicator light will flash and the jacks down buzzer will sound as the vehicle suspension returns to ride height and the jacks retract. The front jacks will retract for 2 seconds before the rear jacks begin to retract. Each jacks red WARNING light will go out. The system will shut down automatically either six minutes after the last WARNING light goes out or thirty minutes after a warning light has failed to go out.

2. The vehicle can be moved as soon as the red warning lights are out, the jacks are in the STORE/TRAVEL position, the green "TRAVEL" light is on, and the suspension air bags are inflated to the vehicles proper ride height.

3. If the jacks fail to retract see the MANUAL JACK RETRACTION section of this manual.

**IMPORTANT:** Thermal expansion caused by heat generated during travel can cause a jack to extend slightly. Only an uninterrupted STORE cycle using the "STORE" button will allow the system to monitor and adjust for thermal expansion.

Manual or Emergency retraction of the jacks, interruptions of power and/or the STORE cycle, changing the ignition key position, pushing the "EMERGENCY STOP", "AUTO LEVEL" or the "AUTO STORE" button on the HWH touch panel or engaging the remote AUTO LEVEL/STORE toggle switch during the STORE cycle will void this system ability until the STORE procedure is reran in it's entirety.

**IMPORTANT:** If a red warning light and buzzer come on while traveling, the jacks should be checked as soon as a safe parking location is found.

---

# OPERATING PROCEDURES

---

## MANUAL HYDRAULIC OPERATION

1. Place transmission in the recommended position for parking the vehicle, and set the parking brake. Turn the ignition to the "ACCESSORY" position.
2. Place pads under the jack feet if the ground will not support the vehicle on the jacks.
3. Push and hold the "DUMP" until all of the air is exhausted from the vehicles suspension system.

**NOTE: With some systems, the "DUMP" button may be momentary. With this system the "DUMP" button must be pushed and held until the air is exhausted from the suspension.**

4. The vehicle may be leveled using the manual EXTEND (UP ARROW) buttons on the right half of the panel. If a yellow LEVEL SENSING light is on, that side or end of the vehicle is low. It is best to level the vehicle side to side first, if needed, before front to rear.

Jacks will extend (or retract) in pairs to raise (or lower) a side or end of the vehicle. Any jack not used for leveling can be extended to the ground. This provides additional stability against wind and activity in the vehicle. Jacks used to stabilize the vehicle after leveling is complete should lift the vehicle slightly after touching the ground.

**IMPORTANT: Do not continue to push an EXTEND button for more than ten (10) seconds after that pair of jacks are fully extended.**

5. When leveling is completed, push the "OFF" button on the touch panel and turn the ignition switch to the "OFF" position.

**IMPORTANT: Push the "STORE" button before traveling when manual operation of the leveling system is used.**

# OPERATING PROCEDURES

## MANUAL JACK RETRACTION

### MANUAL JACK RETRACTION

**WARNING:** KEEP AWAY FROM THE WHEELS, DO NOT CRAWL UNDER THE VEHICLE, KEEP A SAFE DISTANCE IN FRONT AND REAR OF THE VEHICLE. THE VEHICLE MAY DROP AND/OR MOVE FORWARD OR BACKWARD WITHOUT WARNING AS THE VALVE RELEASE IS OPERATED.

**IMPORTANT:** HWH recommends that all HWH room extensions are fully retracted prior to performing manual jack retraction procedures.

Use the manual valve release for retracting the jacks only if the STORE feature on the HWH control panel will not retract the jacks.

1. Locate your power unit-manifold assembly.  
(The diagram below represents a typical Power Unit-Manifold Assembly it may not be an exact match to yours).

**NOTE:** Multiple manifolds may be present on the power unit. The upper most manifold should control jack functions. (Valve styles and arrangements will vary)

2. Allow clearance for the vehicle to lower.

3. Using the diagram below identify the style of your two center valves.

**NOTE:** As of APRIL 2002 a 1/4" Nut Driver has been incorporated into the Breather Cap. Before using read and understand the last page of this manual.

**Large style with T-Handle valve release:** The T-Handle will turn several turns easily. As the valve starts to open, the T-Handle will turn harder. Make sure the valves have been opened far enough to allow the jacks to retract.

**Small style with Valve Release Nut:** DO NOT turn the 1/4" valve release nut more than **4 and 1/2 turns**. Turning the nut more could damage the valve.

**Large style with Valve Release Nut:** The 1/4" Valve release nut is located under a plastic plug that must be removed to gain access. Open valve 1-1/2 to 2 full turns. DO NOT turn the 1/4" valve release nut more than **2 full turns**. Turning the nut more could damage the valve. Replace the protective plastic plug.

4. Retract the front jacks by opening the two center valves. Slowly turn the manual valve releases counter clockwise until the jacks start to retract.

5. Repeat the process by identifying then opening the two outer valves, if applicable.

6. Check that all jacks are now retracted. If yes, continue. If no, notify the dealership where you purchased the vehicle or had the leveling system installed or contact HWH Corporation customer service.

7. Close the valves by turning each valve release clockwise.

**IMPORTANT:** Once the manual valve release is snug, DO NOT tighten the manual valve release past this point as internal damage may occur to the solenoid.

8. The system should now be repaired before using again.

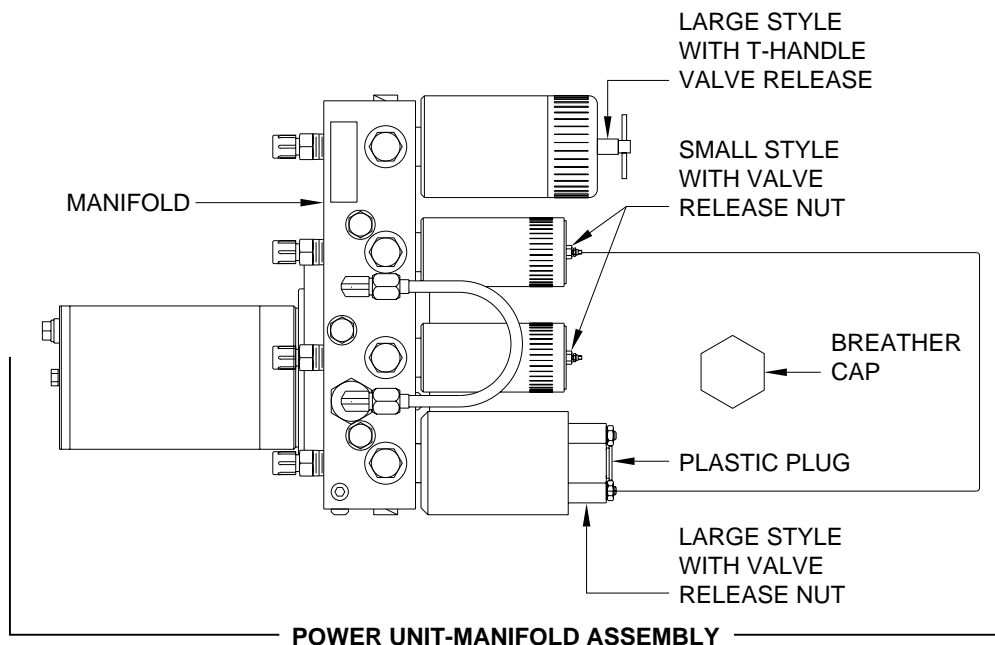

---

# MAINTENANCE

---

## OIL LEVEL

All maintenance should be done as part of the normal servicing of the coach.

The oil level should be checked when the vehicle is first purchased and then once every two years. More often if there is an oil leak in the system.

All four jacks should be completely retracted before checking the oil level.

Refer to the "HYDRAULIC LINE CONNECTION DIAGRAM - MULTIPLE ROOM EXTENSIONS" page for information concerning the correct position of each room before checking the oil level.

The oil reservoir is part of the pump/manifold assembly. The oil level is checked and filled through the breather cap. Clear any dirt away from the breather/filler cap before removing. The oil level should be within one inch of the top of the reservoir. Most breather caps have a dipstick.

**NOTE: Overfilling the tank can cause leakage of oil through the breather cap.**

**FLUID:** HWH Specialty Hydraulic Oil is recommended. In an emergency Dexron automatic transmission fluid can be used. **NOTE:** Dexron automatic transmission fluid contains red dye and can cause staining should a leak occur. **DO NOT USE** brake fluid or hydraulic jack fluid. Use of these can damage seals.

## ELECTRICAL SYSTEM

The batteries should be in good condition and fully charged. Weak batteries can cause erratic operation. Battery cable terminals and battery posts and connections should be kept clean.

All electrical connections, especially ground connections, should be clean, tight, free from corrosion and protected from weathering.

## LEVELING JACKS

There are very few user serviceable parts on the leveling jacks. The jacks require very little maintenance. If the jacks are extremely dirty with caked on mud they should be washed.

The stop rods and retainer pins on the front jacks must be kept in good operating condition. Clean and lubricate the rod and retaining pin regularly.

The jack rods should NOT be wiped and do not need to be oiled or sprayed with anything.

## ROOM EXTENSIONS

The HWH room mechanisms need no maintenance. DO NOT grease or lubricate any parts of the HWH mechanism.

Any visible mechanism can be kept clean by washing with water. Refer to the vehicle manufacturer for correct maintenance of the room seals.

## VISUAL INSPECTION

Periodically inspect the leveling system for oil leaks and damaged or missing parts, such as pivot bolts or springs. Check the hydraulic lines and wiring for damage and wear. Check that the jacks do not interfere with any parts of the vehicle when they are in the "STORE" position.

The jacks should be cycled at least once a month or whenever the coach is serviced. The system will operate better if kept clean and free from caked on mud or ice.

## OPERATIONAL CHECK

Review the OPERATOR MANUAL. Run the system according to the SYSTEM OPERATION (LEVELING) Section. Note any abnormal operation.

Review the "JACK RETRACTION" Section. Make sure the jacks will fully retract to the "STORE" position. Jacks should not interfere with any of the coach when in the "STORE" position.

Check that all lights work according to the "INDICATOR LIGHT" Section. Correct function of the red "WARNING" light is important.

**NOTE: All major components of the system can be replaced with rebuilt units or if the system is out of warranty, parts can be sent to HWH CORPORATION to be rebuilt.**

# SENSING UNIT MAINTENANCE/SERVICE

## SENSING UNIT ADJUSTMENT

Level the vehicle by placing a bubble level in the center of the freezer floor or upon whichever surface within the vehicle that is to be level. Using the Leveling System and the bubble level, ignoring the yellow LEVEL lights on the Touch Panel, level the vehicle until the bubble is centered.

With the vehicle level according to the bubble level, if there are no yellow lights lit on the Touch Panel, the sensing unit is properly adjusted. If there are yellow LEVEL lights lit on the Touch Panel, manual adjustments to the Sensing Unit are needed. A Phillips screw driver or sockets w/driver or box end wrenches of 7/8, 3/4, 1/2, 5/16 or 1/4 sizes will be needed.

The Sensing Unit is mounted inside the Control Box. The Control Box is mounted to the power unit/valve assembly.

There are four LED's on the Sensing Unit, A,B,C and D. Refer to the drawing below. The Sensing Unit is adjusted by turning the adjustment nut to turn out LED's B and D. The adjustment screw will turn out LED's A and C. If the adjustment nut has to be turned more than 1/2 flat or the adjustment screw has to be turned more than 3/4 turn to turn the LED out, there may be a problem with the Sensing Unit or the mounting of the Control Box. If two LED's are on, it is best to make the B-D adjustments first, then hold the adjustment nut from moving while making the A-C adjustment.

**NOTE: If opposing LED's are lit, there is a problem with the Sensing Unit.**

**If LED (A) is lit: Turn the adjustment screw COUNTER CLOCKWISE until the LED is off.**

**If LED (C) is lit: Turn the adjustment screw CLOCKWISE until the LED is off.**

**If LED (B) is lit: Turn the adjustment nut COUNTER CLOCKWISE until the LED is off.**

**If LED (D) is lit: Turn the adjustment nut CLOCKWISE until the LED is off.**

**IMPORTANT: When all 4 LED's are off, move the vehicle to an unlevel position so one or two yellow lights are on. Level the vehicle according to the yellow LEVEL lights. Recheck the level. If more adjustment is needed, DO NOT try to adjust the sensing unit until the yellow level lights go out, instead just "tweak" the sensing unit, ignoring the LED's on the sensing unit.**

**Example: After the initial adjustment and releveling the vehicle, the front is still low. This means the front yellow level light is turning off too soon. Determine which sensing unit light is the front light, A-B-C or D. Move the adjustment for that light very, very, slightly in the OPPOSITE direction that is given in the above instructions for LED's A, B, C, and D. This will allow**

**the front yellow light to stay on slightly longer to bring the front up more. Again, unlevel the vehicle then relevel the vehicle using the yellow level lights on the touch panel. Recheck with a level. Repeat the "tweaking" process until the system levels the vehicle properly.**

**ADJUSTMENT NUT (5/16" OLD) - (1/2" NEW)**

**ADJUSTMENT SCREW (Phillips or 1/4") (OLD STYLE)**

**ADJUSTMENT NUT (7/8" or 3/4")**

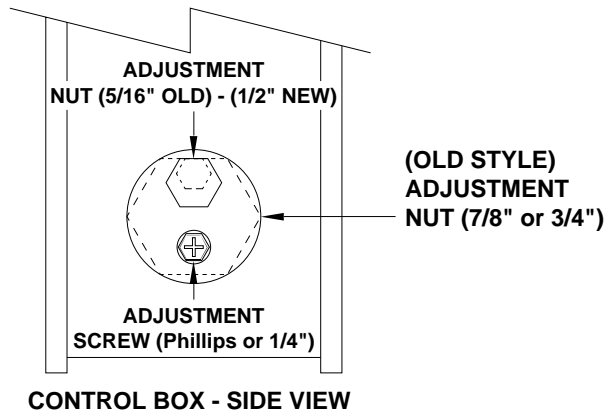
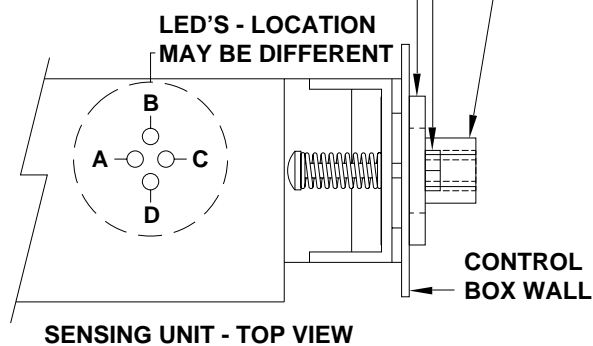

## NOT IN PARK/BRAKE CHECK

**CAUTION: WHEN MAKING THIS CHECK, BLOCK THE COACH WHEELS SECURELY SO THE COACH CANNOT ROLL FORWARD OR BACKWARD.**

Set the park/brake. Switch the ignition to the "ACC" or "ON" position. Push the "ON/OFF" switch toward "ON". Release the parking brake and confirm that the "PARK" indicator light comes on. Reset the parking brake. The "PARK" indicator light should go out. Switch the ignition to "OFF".

If any of the above checks or inspections reveal a problem or if there are other problems or questions, consult a qualified RV repair center, your vehicle or coach manufacturer, or HWH CORPORATION for service or repair.

# BREATHER CAP - DIPSTICK - 1/4" NUT DRIVER

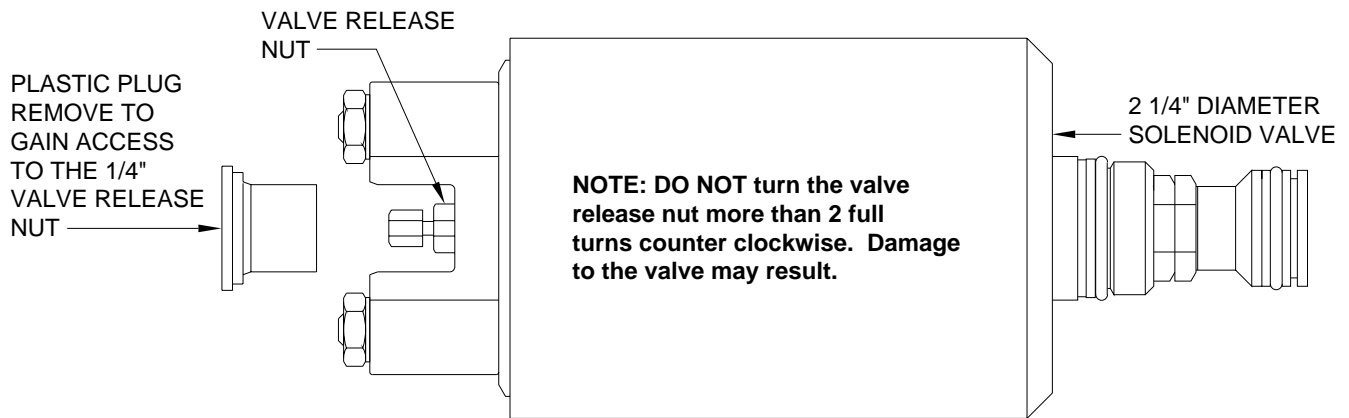
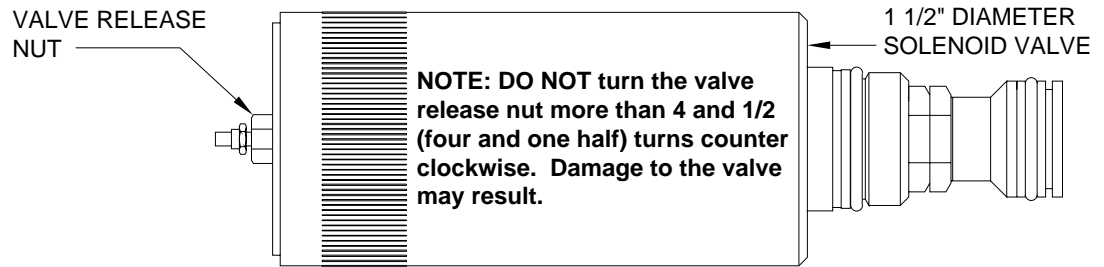

**NOTE: THE BREATHER CAP IS LOCATED ON THE TOP SIDE OF THE POWER UNIT RESERVOIR.**

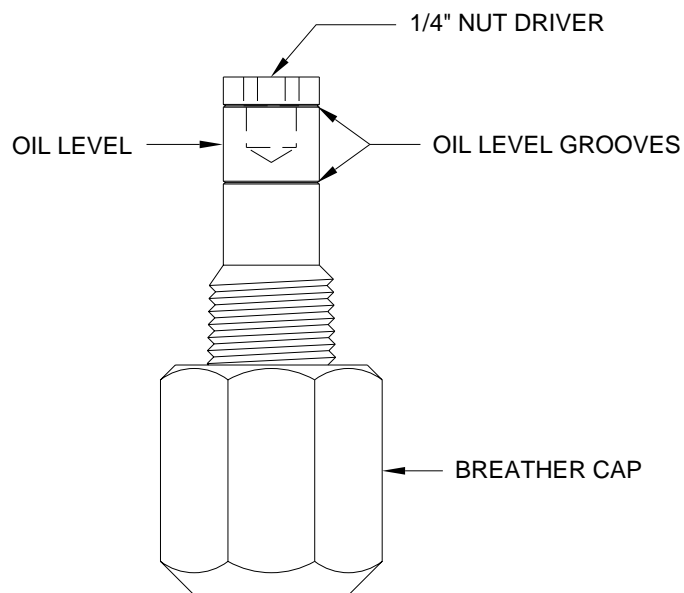

**IMPORTANT: PRIOR TO REMOVING THE BREATHER CAP, EITHER TO CHECK THE OIL LEVEL OR TO USE THE 1/4" NUT DRIVER, CLEAN ANY DEBRIS FROM THE TOP OF THE RESERVOIR. BEFORE RETURNING THE BREATHER CAP TO THE RESERVOIR, REMOVE ANY PAINT CHIPS OR OTHER DEBRIS FROM THE DIPSTICK INCLUDING DEBRIS INSIDE THE 1/4" NUT DRIVER.**