



OPERATOR'S MANUAL

HWH® COMPUTER-CONTROLLED 625 SERIES LEVELING SYSTEM AND SPACEMAKER® ROOM EXTENSION SYSTEM

FEATURING:

*Touch Panel Leveling Control
BI-AXIS® Hydraulic Leveling
Straight-Acting Jacks
With Auto Pilot Dump
One Room Extension*

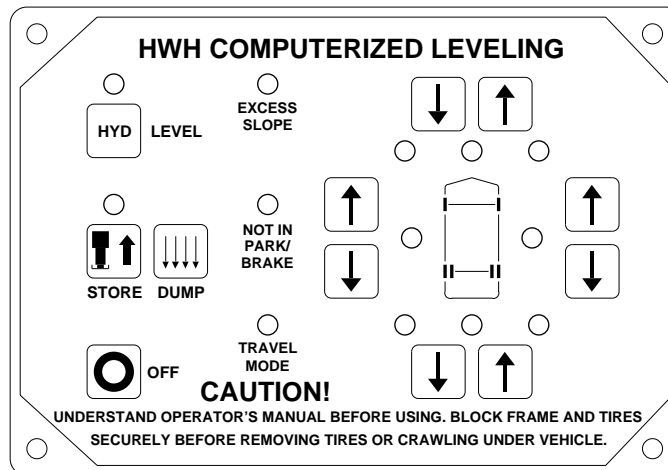

HWH CORPORATION
(On I-80, Exit 267 South)
2096 Moscow Road | Moscow, Iowa 52760
Ph: 800/321-3494 (or) 563/724-3396 | Fax: 563/724-3408
www.hwh.com

OPERATOR'S MANUAL

CAUTION !

READ THE ENTIRE OPERATOR MANUAL BEFORE OPERATING.

BLOCK FRAME AND TIRES SECURELY BEFORE CRAWLING UNDER VEHICLE. DO NOT USE LEVELING JACKS OR AIR SUSPENSION TO SUPPORT VEHICLE WHILE UNDER VEHICLE OR CHANGING TIRES. VEHICLE MAY DROP AND/OR MOVE FORWARD OR BACKWARD WITHOUT WARNING CAUSING INJURY OR DEATH.

KEEP ALL PEOPLE CLEAR OF VEHICLE WHILE OPERATING LEVELING SYSTEM OR ROOM EXTENSIONS.

KEEP ALL PEOPLE CLEAR OF VEHICLE WHILE DUMPING AIR FROM THE VEHICLE'S SUSPENSION.

DO NOT MOVE THE VEHICLE IF THE VEHICLE IS NOT AT THE PROPER RIDE HEIGHT. CONTACT MANUFACTURER TECHNICAL SERVICE FOR MOVING THE VEHICLE WHEN NOT AT THE PROPER RIDE HEIGHT.

WEAR SAFETY GLASSES WHEN INSPECTING OR SERVICING THE SYSTEM TO PROTECT EYES FROM DIRT, METAL CHIPS, OIL LEAKS, ETC. FOLLOW ALL OTHER APPLICABLE SHOP SAFETY PRACTICES.

IMPORTANT: IF COACH IS EQUIPPED WITH A ROOM EXTENSION, READ ROOM EXTENSION SECTION BEFORE OPERATING LEVELING SYSTEM.

HOW TO OBTAIN WARRANTY SERVICE

THIS IS NOT TO BE INTERPRETED AS A STATEMENT OF WARRANTY

HWH CORPORATION strives to maintain the highest level of customer satisfaction. Therefore, if you discover a defect or problem, please do the following:

FIRST: Notify the dealership where you purchased the vehicle or had the leveling system installed. Dealership management people are in the best position to resolve the problem quickly. If the dealer has difficulty solving the problem, he should immediately contact the Customer Service Department, at HWH CORPORATION.

SECOND: If your dealer cannot or will not solve the problem, notify the Customer Service Department:
HWH CORPORATION 2096 Moscow Rd. Moscow IA. 52760
(563) 724-3396 OR (800) 321-3494. Give your name and address, coach manufacturer and model year, date the coach was purchased, or the date of system installation,

description of the problem, and where you can be reached during business hours (8:00 a.m. till 5:00 p.m. c.s.t.). HWH CORPORATION personnel will contact you to determine whether or not your claim is valid. If it is, HWH CORPORATION will authorize repair or replacement of the defective part, either by appointment at the factory or by the authorization of an independent service facility, to be determined by HWH CORPORATION. All warranty repairs must be performed by an independent service facility authorized by HWH CORPORATION, or at the HWH CORPORATION factory, unless prior written approval has been obtained from proper HWH CORPORATION personnel.

CONTROL IDENTIFICATION

625 SERIES LEVELING SYSTEM

COMPUTER-CONTROL

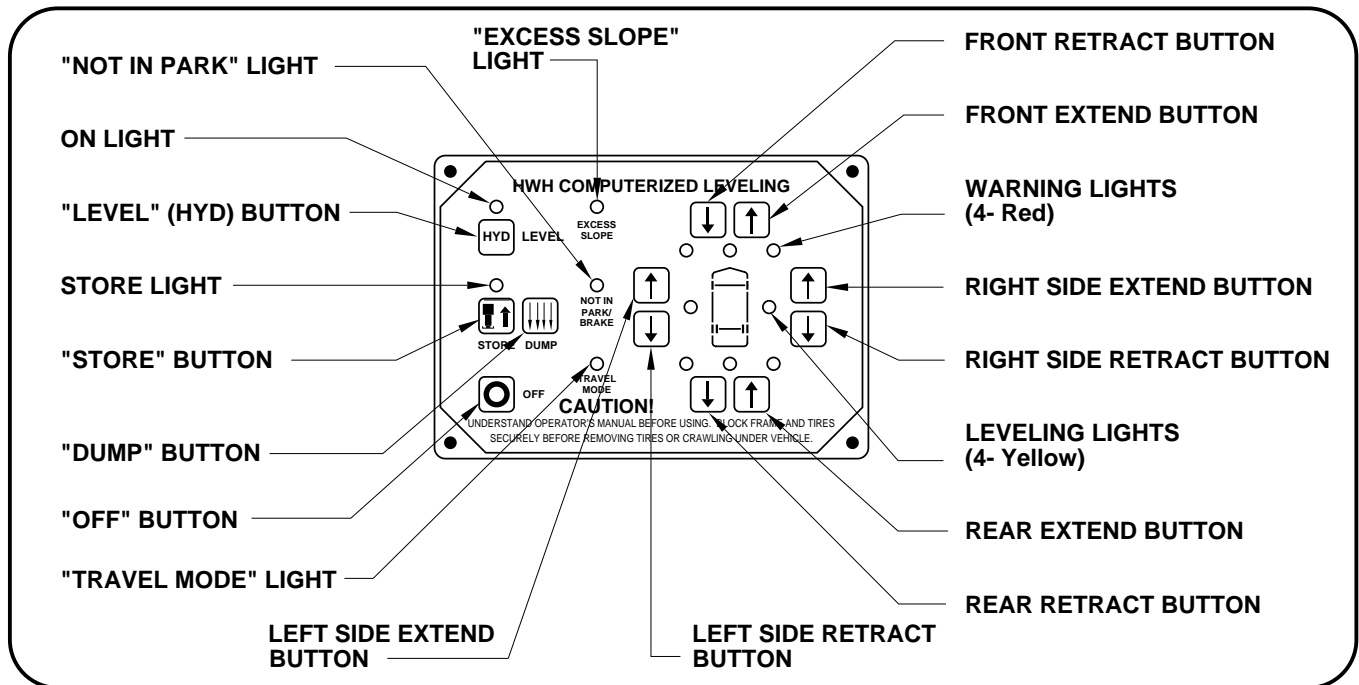

CONTROL FUNCTIONS

CONTROL BUTTONS

"OFF" BUTTON: Push the "OFF" button to stop hydraulic operation.

"LEVEL" (HYD) BUTTON: This is the on button and automatic operation button. The ON indicator light is above the "HYD" button.

"STORE" BUTTON: The store indicator light is above the "STORE" button. This button is used to automatically retract the jacks.

"DUMP" BUTTON: This is a manual button for dumping air from the vehicle suspension.

EXTEND BUTTONS (UP ARROWS): These buttons will extend their respective jack pairs to lift the vehicle.

RETRACT BUTTONS (DOWN ARROWS): These buttons will retract their respective jack pairs to lower the vehicle.

INDICATOR LIGHTS

LEVELING LIGHTS: The four yellow indicating lights are level sensing indicators. When a yellow light is on, it indicates that its side, end, or corner of the vehicle is low. No more than two lights should be on at the same time.

WARNING LIGHTS: The four red lights surrounding the yellow level indicators are jacks down WARNING lights. They are functional only when the ignition is in the "ON" or "ACC" position, the system is on, and the jacks are extended 1/4 to 1/2 inch.

"EXCESS SLOPE" LIGHT: This indicator will light when the leveling system cannot level the vehicle.

"NOT IN PARK/BRAKE" LIGHT: This indicator will light when the hand/auto brake is not set and the "LEVEL" button is being pushed.

"TRAVEL MODE" LIGHT: This indicator light will be on when the ignition is on, when the jacks are retracted and there are no red WARNING lights on.

MASTER "JACKS DOWN" WARNING LIGHT: This is a light mounted in the dash separate from the touch panel. It will be on when any one or more jacks are extended and the ignition is "ON".

BUZZER: This is a jacks down warning. It will sound if the master "JACKS DOWN" warning light is on.

CONTROL IDENTIFICATION

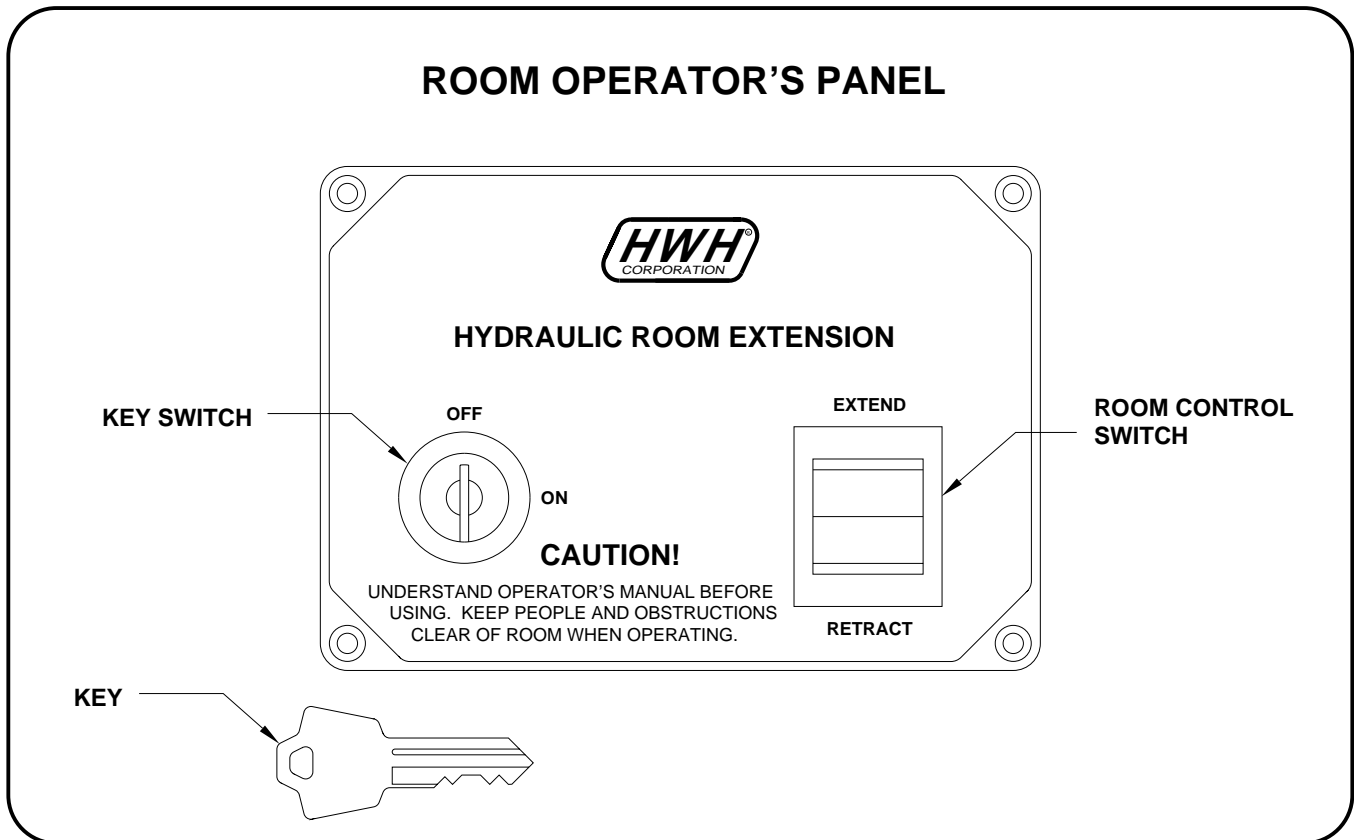

CONTROL FUNCTIONS

KEY SWITCH: The KEY SWITCH controls power to the ROOM CONTROL SWITCH. When the KEY SWITCH is in the "ON" POSITION the room can be operated, and the key cannot be removed. When the KEY SWITCH is in the "OFF" position the room cannot be operated, and the key can be removed.

ROOM CONTROL SWITCH: The ROOM CONTROL SWITCH is a two position momentary switch. Pressing the switch in the EXTEND POSITION will extend the room. Pressing the switch in the RETRACT POSITION will retract the room. Releasing the ROOM CONTROL SWITCH will halt the operation of the room.

OPERATING PROCEDURES

GENERAL INSTRUCTIONS

Maintain adequate clearance in all directions for vehicle, room extensions, awnings, doors, steps, etc. Vehicle may move in any direction due to jacks extending or retracting, settling of the jacks or the vehicle, equipment malfunction, etc..

If parking on soft ground or asphalt paving, a wood block or pad should be placed under each jack.

Press the "OFF" button or turn the ignition switch "OFF" at any time to stop the operation of the system.

Any time a hydraulic leveling process is interrupted, retract the jacks according to the JACK RETRACTION Section and then restart the leveling process.

If the hand / auto brake is not set when the "HYD" button is pressed, the "NOT IN PARK/BRAKE" light will come on. When the "HYD" button is released the "NOT IN PARK/BRAKE" light will go out. The panel will NOT turn on.

CAUTION: DO NOT MOVE THE VEHICLE IF ONE OR MORE JACKS ARE EXTENDED TO THE GROUND.

PREPARATION FOR TRAVEL

Before traveling, the red jack warning lights must be off and the "TRAVEL MODE" light must be on. If lights are not correct for travel, retract jack as described in the JACK RETRACTION Section.

If the jacks are retracted but a red "WARNING" light is lit or the green "TRAVEL MODE" light is not lit, the system needs to be serviced.

Any room extension or generator slide should be fully retracted before traveling.

CAUTION: DO NOT MOVE THE VEHICLE WHILE THE LEVELING JACKS ARE STILL IN CONTACT WITH THE GROUND OR IN THE EXTEND POSITION. THIS VEHICLE IS EQUIPPED WITH STRAIGHT-ACTING JACKS. MOVING THE VEHICLE WITH THE LEVELING JACKS EXTENDED CAN CAUSE SEVERE DAMAGE TO THE JACKS

AND OR THE VEHICLE AND CREATE A DRIVING HAZARD. DO NOT RELY SOLELY UPON WARNING LIGHTS. IT IS THE OPERATOR'S RESPONSIBILITY TO CHECK THAT ALL JACKS ARE FULLY RETRACTED INTO THE STORE/TRAVEL POSITION AND THE VEHICLE IS AT THE PROPER RIDE HEIGHT FOR TRAVELING. CONTACT MANUFACTURER TECHNICAL SERVICE BEFORE MOVING A VEHICLE THAT IS NOT AT PROPER TRAVEL HEIGHT.

IMPORTANT: Any time the "HYD" button has been pushed, push the "STORE" button before traveling.

If the jacks cannot be retracted according to the JACK RETRACTION Section, retract the jacks according to the MANUAL JACK RETRACTION Section. The system should then be checked.

OPERATING PROCEDURES

625 SERIES LEVELING SYSTEM

AUTOMATIC HYDRAULIC LEVELING

1. Place transmission in the recommended position for parking vehicle and set parking brake. Turn the coach engine off. Turn the ignition to the "ACCESSORY" position.
2. Press the "LEVEL" button to enter the hydraulic operation mode. The ON light will glow steady.
3. At this time, the operator may want to check the jacks and place a pad under each jack if the ground will not support the vehicle.
4. Press the "LEVEL" button a second time. The ON light will start to flash.

NOTE: After pushing the "LEVEL" button a second time, the system will begin to dump air from the vehicle suspension. After approximately 25 seconds, the leveling process will begin.

The system will automatically extend the jacks to level the vehicle and then extend any remaining jacks for stabilizing. After the system has finished leveling and stabilizing, and has completed the air dump cycle, it will automatically shut off.

EXCESS SLOPE SITUATION: In the event the jacks are unable to level the coach, the "EXCESS SLOPE" light will come on. Excess slope is two jacks fully extending without turning the yellow level light out. The system will not stabilize the vehicle if the "EXCESS SLOPE" light comes on. One or more jacks may not be extended. The system will shut off leaving the "EXCESS SLOPE" light on. The "EXCESS SLOPE" light will remain on if the ignition is in the "ON" or "ACC" position, until the jacks have been fully retracted turning the red warning lights out. Push the "STORE" button to retract the jacks. Move the vehicle to a more level position or level the vehicle as close as possible according to the MANUAL HYDRAULIC OPERATION section.

5. Turn the ignition switch to the "OFF" position.

JACK RETRACTION

CAUTION: THE OPERATOR MUST BE SURE THAT THERE ARE NO OBJECTS UNDER THE VEHICLE AND THAT ALL PEOPLE ARE CLEAR OF THE VEHICLE.

1. Start the engine. Store the jacks immediately.

NOTE: When the jacks are stored with the ignition in the ON position, the warning buzzer will sound until the jacks have retracted to the STORE position. If desired, the jacks can be stored with the ignition key in the accessory position. This will eliminate the warning buzzer while the jacks are retracting.

2. Press the "STORE" button. The store indicator light will flash. The vehicle suspension will start to return to ride height. The front jacks will retract for 2 seconds before the rear jacks will begin to retract. As each jack retracts, its red WARNING light will go out. The system will automatically shut down six minutes after the four individual red "WARNING" lights are out. If any one red "WARNING" light does not go out, the system will continue to store for thirty minutes, then shut down regardless of the "WARNING" lights condition.

NOTE: When traveling thermal expansion may cause a jack to extend slightly. When the "STORE" button has been used to retract the jacks, the system will automatically retract any jack that extends due to thermal expansion.

IMPORTANT: Pushing the "OFF" button or turning the ignition key will stop the STORE procedure. Any time the STORE procedure is stopped before all 4 red Warning Lights go out, the jacks should be completely retracted by pushing the "STORE" button before traveling.

CAUTION: DO NOT MOVE THE VEHICLE WHILE THE LEVELING JACKS ARE STILL IN CONTACT WITH THE GROUND OR IN THE EXTEND POSITION. THIS VEHICLE IS EQUIPPED WITH STRAIGHT-ACTING JACKS. MOVING THE VEHICLE WITH THE LEVELING JACKS EXTENDED CAN CAUSE SEVERE DAMAGE TO THE JACKS AND OR THE VEHICLE AND CREATE A DRIVING HAZARD. DO NOT RELY SOLELY UPON WARNING LIGHTS. IT IS THE OPERATOR'S RESPONSIBILITY TO CHECK THAT ALL JACKS ARE FULLY RETRACTED INTO THE STORE/TRAVEL POSITION AND THE VEHICLE IS AT THE PROPER RIDE HEIGHT.

3. The vehicle can be moved as soon as the red warning lights are out, the jacks are in the STORE/TRAVEL position, the green "TRAVEL" light is on, and the suspension air bags are inflated to the vehicles proper ride height.

IMPORTANT: If a red warning light and buzzer come on while traveling, the jacks should be checked as soon as a safe parking location is found.

4. If jacks cannot be retracted by the above procedure see MANUAL JACK RETRACTION Section.

NOTE: If the vehicle is parked or stored with the jacks extended for an extended period of time and the jacks fail to retract completely, extend the jacks back down to the ground then retract the jacks again.

OPERATING PROCEDURES

MANUAL HYDRAULIC OPERATION

1. Place transmission in the recommended position for parking the vehicle, and set the parking brake. Turn the ignition to the "ACCESSORY" position.
2. Press the "HYD" button. The indicator light will glow steady.
3. Place pads under the jack feet if the ground will not support the vehicle on the jacks.
4. Push the "DUMP" button. Wait until all of the air is exhausted from the vehicles suspension system.
5. The vehicle may be leveled using the manual EXTEND (UP ARROW) buttons on the right half of the panel. If a yellow LEVEL SENSING light is on, that side or end of the vehicle is low. It is best to level the vehicle side to side first, if needed, before front to rear.

Jacks will extend (or retract) in pairs to raise (or lower) a side or end of the vehicle. Any jack not used for leveling can be extended to the ground. This provides additional stability against wind and activity in the vehicle. Jacks used to stabilize the vehicle after leveling is complete should lift the vehicle slightly after touching the ground.

IMPORTANT: Do not continue to push an EXTEND button for more than ten (10) seconds after that pair of jacks are fully extended.

6. When leveling is completed, push the "OFF" button on the touch panel and turn the ignition switch to the "OFF" position.

IMPORTANT: Push the "STORE" button before traveling when manual operation of the leveling system is used.

MANUAL JACK RETRACTION

The solenoid valves on the power unit valve assembly are equipped with a manual valve release. The large valves have a valve release T-Handle. The small valves have a valve release nut. Use the manual valve release for retracting only if the "STORE" button on the control panel will not retract the jacks for travel.

NOTE: Some assemblies have 4 large valves, some have 4 small valves and some will have 2 large valves in the outer positions and 2 small valves in the center positions.

CAUTION: KEEP AWAY FROM THE WHEELS, DO NOT CRAWL UNDER THE VEHICLE, KEEP A SAFE DISTANCE IN FRONT AND REAR OF THE VEHICLE. THE VEHICLE MAY DROP AND/OR MOVE FORWARD OR BACKWARD WITHOUT WARNING AS THE VALVE RELEASE IS OPERATED.

1. Locate the manual valve release on each solenoid valve. The solenoid valves are located on the power unit/valve assembly.
2. Allow clearance for the vehicle to lower.

IMPORTANT: Only open the valves enough to retract the jacks. DO NOT turn valve release nuts more than 4 and 1/2 turns. Turning the nuts more could damage the valves.

Valve release T-Handles will turn several turns easily. As the valve starts to open, the T-Handles will turn harder. Make sure the valves have been opened far enough to allow the jacks to retract.

3. Retract the front jacks by opening the two center valves. Slowly turn the manual valve releases counter clockwise until the jacks start to retract.

4. Repeat the process for the rear jacks by opening the two outer valves.

NOTE: Prior to APRIL 2002 a 1/4" Nut Driver was sent with the Operators Manual. As of APRIL 2002 the 1/4" Nut Driver has been incorporated into the Breather Cap. See the back page of this manual for further info.

5. Check that all four jacks are now retracted.
6. Close the valves by turning the manual valve releases clockwise.

IMPORTANT: Once the manual valve release is snug, DO NOT tighten the manual valve release past this point as internal damage may occur to the solenoid.

7. The system should now be repaired before using again.

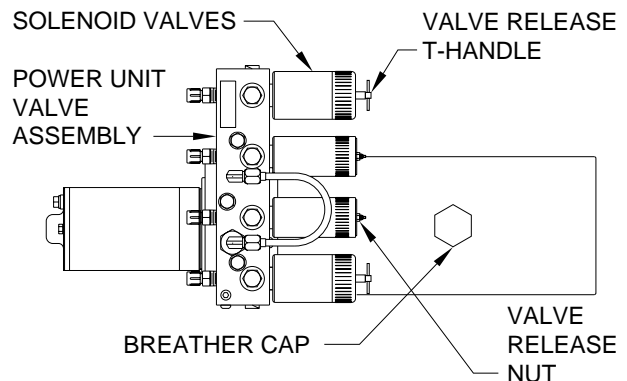

**MP35.3840
12MAY04**

OPERATING PROCEDURES

ROOM EXTEND PROCEDURE

CAUTION: OPERATING THE ROOM WITH ANY ROOM-LOCKING DEVICES LOCKED OR THE MANUAL-RETRACT WINCH ATTACHED CAN CAUSE PERSONAL INJURY AND VEHICLE DAMAGE. IT IS THE OPERATOR'S RESPONSIBILITY TO ENSURE THAT ALL ROOM-LOCKING DEVICES AND THE MANUAL RETRACT WINCH ARE DISENGAGED BEFORE OPERATING THE ROOM.

1. Unlock all room-locking devices.

NOTE : If the MANUAL RETRACT WINCH is attached to the room remove it before extending the room.

CAUTION: KEEP PEOPLE AND OBSTRUCTIONS CLEAR OF ROOM WHEN OPERATING.

NOTE : Make sure there is adequate clearance to fully extend the room.

2. Turn the ignition key to the "ON" or "ACC" position. **THE PARK BRAKE MUST BE SET FOR THE ROOM TO OPERATE.**

3. To extend the room, press and hold the ROOM CONTROL SWITCH in the "EXTEND" position until the room is fully extended.

NOTE: Hold the switch to "EXTEND" three or four seconds after the room is fully extended. This assures proper pressurization of the cylinders. **During normal operation of the room, do not reverse direction of the room until the room is fully extended. If necessary, the direction of the room may be reversed, but watch for binding of the room. If the direction of the room has been reversed, DO NOT re-extend the room until the room has been fully retracted.**

IMPORTANT: Do not hold the ROOM CONTROL SWITCH in the "EXTEND" position for more than ten seconds after the room is fully extended or stops moving. **If either side of the room stops moving, release the room control switch immediately. DO NOT force the room. DO NOT reverse direction of the room, contact HWH Customer Service for assistance 1-800-321-3494.**

NOTE : Releasing the ROOM CONTROL SWITCH will halt the operation of the room.

4. Turn the ignition to the "OFF" POSITION.

ROOM RETRACT PROCEDURE

CAUTION: KEEP PEOPLE AND OBSTRUCTIONS CLEAR OF ROOM WHEN OPERATING.

1. Turn the ignition key to the "ON" or "ACC" position. **THE PARK BRAKE MUST BE SET FOR THE ROOM TO OPERATE.**

2. To retract the room press and hold the ROOM CONTROL SWITCH in the "RETRACT" position until the room is fully retracted.

NOTE: Hold the switch to "RETRACT" three or four seconds after the room is fully retracted. This assures proper pressurization of the cylinders. **During normal operation of the room, do not reverse direction of the room until the room is fully retracted. If necessary, the direction of the room may be reversed, but watch for binding of the room. If the direction of the room has been reversed, DO NOT retract the room until the room has been fully extended.**

IMPORTANT: Do not hold the ROOM CONTROL SWITCH in the "RETRACT" position for more than ten seconds after the room is fully retracted or stops moving. **If either side of the room stops moving, release the room control switch immediately. DO NOT force the room. DO NOT reverse direction of the room, contact HWH Customer Service for assistance 1-800-321-3494.**

NOTE: Releasing the ROOM CONTROL SWITCH will halt the operation of the room.

3. Turn the ignition to the "OFF" POSITION.

4. Engage all room-locking devices.

5. If the room will not retract see the MANUAL ROOM RETRACT PROCEDURE.

IMPORTANT: Room-locking devices should be locked while traveling.

MANUAL ROOM AND GENERATOR SLIDE RETRACT PROCEDURE (WITH SOLENOID VALVES WITH VALVE RELEASE NUTS)

(USE ONLY WHEN THE ROOM WILL NOT RETRACT WITH THE ROOM CONTROL SWITCH)

OVERVIEW

The room can be retracted manually if a hydraulic or electric failure prevents the room from being retracted using the CONTROL SWITCH. For normal retract sequence see the ROOM SLIDE RETRACT PROCEDURES. Refer to the vehicle manufacturer for storage location of the winch and information for connecting the winch to the room.

IMPORTANT: If the vehicle is not equipped with a winch, DO NOT use other pulling devices to retract the room. Follow steps 2 and 3 and try pushing the room in. Contact the vehicle manufacturer or HWH Customer Service at 1-800-321-3494 or 563-724-3396 for assistance.

CAUTION: THE MANUAL RETRACT WINCH IS EQUIPPED FOR MANUALLY RETRACTING THE ROOM ONLY. IT IS NOT TO BE USED FOR LIFTING OR ANY OTHER APPLICATION. HIGH FORCES ARE CREATED WHEN USING A WINCH, CREATING POTENTIAL SAFETY HAZARDS. FAILURE TO FOLLOW ALL CAUTIONS AND INSTRUCTIONS MAY CAUSE FAILURE OF THE MANUAL RETRACT WINCH OR CONNECTIONS RESULTING IN DAMAGE OR PERSONAL INJURY. MAINTAIN FIRM GRIP ON THE WINCH HANDLE AT ALL TIMES. NEVER RELEASE THE HANDLE WHEN RATCHET LEVER IS IN THE OFF POSITION AND THE WINCH IS LOADED. THE WINCH HANDLE COULD SPIN VIOLENTLY AND CAUSE PERSONAL INJURY. CHECK THE WINCH AND STRAPS FOR DAMAGE OR WEAR, AND CHECK FOR PROPER RATCHET OPERATION ON EACH USE OF THE WINCH. DO NOT USE IF DAMAGED OR WORN.

1. Retract jacks following the LEVELING SYSTEM RETRACT PROCEDURE.

NOTE : When manually retracting the room, make sure the jacks are retracted before retracting the room.

2. Locate the HYDRAULIC PUMP/MANIFOLD unit.

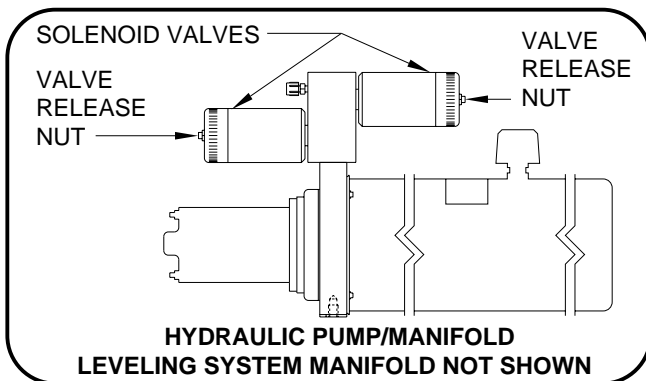

3. Open the Solenoid Valves by slowly turning the valve release nuts counter clockwise using the 1/4" nut driver supplied.

IMPORTANT: Only open the valves enough to retract the room. DO NOT turn the release nuts more than 4 and 1/2 turns. Turning the nuts more could damage the valves.

NOTE: Prior to APRIL 2002 a 1/4" Nut Driver was sent with the Operators Manual. As of APRIL 2002 the 1/4" Nut Driver has been incorporated into the Breather Cap. See the back page of this manual for further info.

NOTE: The room may move slightly as the SOLENOID VALVES are opened and internal pressure is released.

4. Locate the MANUAL RETRACT WINCH and connect it to the room according to the vehicle manufacturer's instructions. To extend the WINCH STRAP firmly grasp WINCH HANDLE, place RATCHET LEVER in its OFF position, and slowly rotate the WINCH HANDLE counter clockwise, keeping a firm grip on the handle. When enough WINCH STRAP is extended, place the RATCHET LEVER in its ON position and slowly rotate the WINCH HANDLE clockwise until the RATCHET LEVER locks.

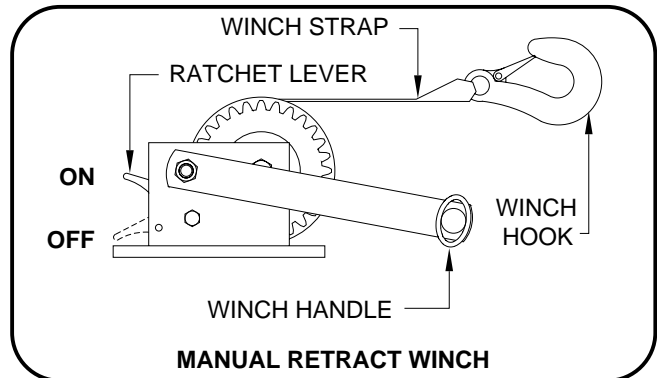

5. Slowly winch the room in by turning the WINCH HANDLE clockwise. The RATCHET LEVER should produce a loud, sharp, clicking noise.

NOTE: Winching the room in quickly will raise pressure in the hydraulic fluid and make winching more difficult.

CAUTION: OPERATE THE MANUAL RETRACT WINCH BY HAND POWER ONLY. IF THE WINCH CANNOT BE CRANKED EASILY WITH ONE HAND IT IS PROBABLY OVERLOADED. IF WINCHING BECOMES TOO DIFFICULT STOP AND CHECK FOR OBSTRUCTIONS OR RESTRICTIONS ON THE ROOM AND ROOM EXTENSION MECHANISM.

6. When the room is fully retracted, engage the room locking devices. Leave the retract winch engaged and the solenoid valves open.

CAUTION: THE ROOM EXTENSION SOLENOID VALVE RELEASE NUTS MUST BE IN THE OPEN POSITION WHEN THE MANUAL RETRACT WINCH IS ENGAGED.

7. The system should be repaired before using again.

NOTE: After repairs are made, when closing the VALVE RELEASE NUTS, do not over tighten the nuts.

MP35.952D
01MAY02

OPERATING PROCEDURES

"LEVEL-OUT" ROOM EXTENSION MECHANISM

MANUAL ROOM RETRACTION PROCEDURES

1. Determine which extend and retract solenoid valves are assigned to the room. Manually open the valve release nuts for the extend and retract solenoid valves by turning the 1/4" release nuts counter clockwise 4 and 1/2 turns. Turning the nuts more could damage the valves.

NOTE: The breather cap dip stick is also a 1/4" nut driver.

2. Gain access to the 13/16" Manual Retraction Bolts (one on each mechanism) by raising the STORE-MORE access panel.

3. Remove the Thumb Screws (one on each mechanism) completely by turning them counterclockwise.

4. Using wrench provided, a personal wrench or a tire iron with a 13/16" or 21mm opening rotate either mechanism's Manual Retraction Bolt clockwise 6 complete turns.

5. Move to the second room extension mechanism, rotate the Manual Retraction Bolt clockwise 12 complete turns.

6. Return to the first room extension mechanism and rotate the Manual Retraction Bolt clockwise 12 complete turns.

7. Repeat steps 4 and 5 alternating from mechanism to mechanism rotating each Manual Retraction Bolt 12 complete turns until room is sealed. (DO NOT exceed 15 ft.lbs) Make sure the room does not bind.

8. Replace both Thumb Screws. Leave the manual valve releases open.

IMPORTANT: If at any stage something is not understood or if the room begins to bind DO NOT force the room, contact HWH Customer Service for assistance 1-800-321-3494.

IMPORTANT: DO NOT EXTEND THE ROOM UNTIL THE STEPS BELOW HAVE BEEN COMPLETED!

1. Gain access to the 13/16" Manual Retraction Bolts (one on each mechanism) by raising the STORE-MORE access panel.

2. Remove the Thumb Screws (one on each mechanism) completely by turning them counterclockwise.

3. If needed, using wrench provided, a personal wrench or a tire iron with a 13/16" or 21mm opening rotate either mechanism's Manual Retraction Bolt counterclockwise until resistance is met.

4. Move to the second room extension mechanism and repeat step 3.

5. Replace both Thumb Screws.

6. Close both manual valve releases assigned to the room. Turn the valve release nuts clockwise until snug. **DO NOT over tighten.**

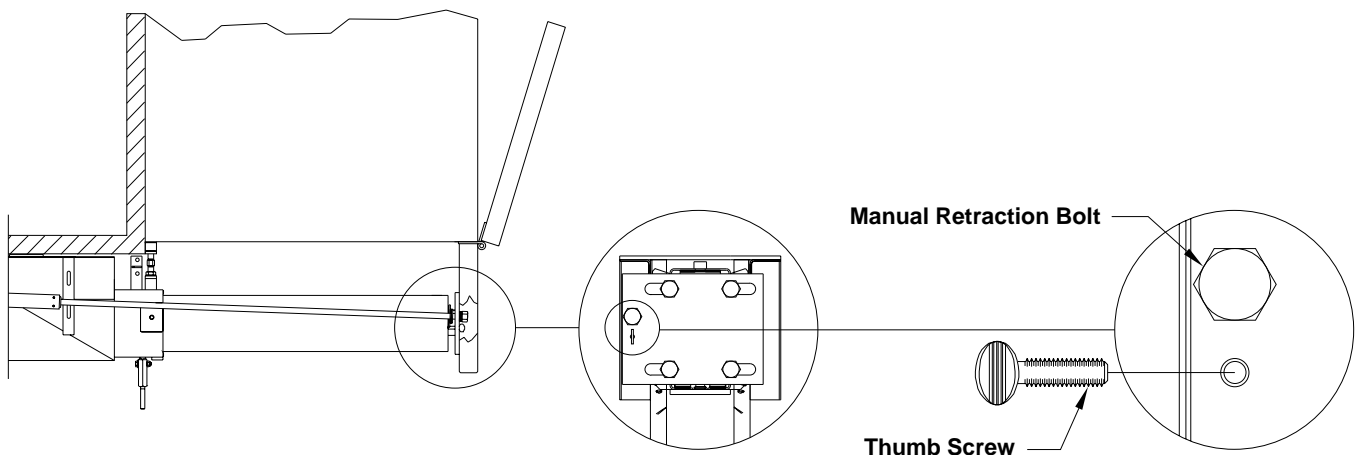
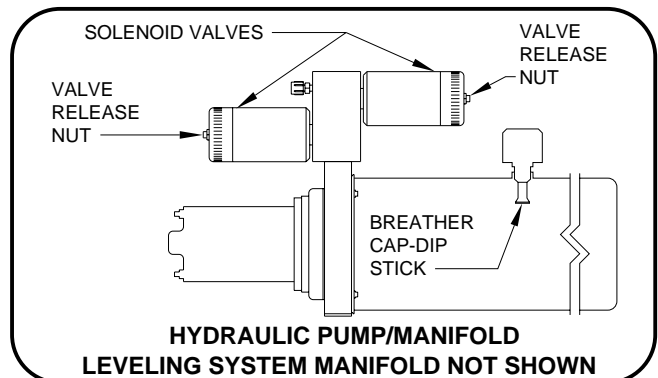

MAINTENANCE

OIL LEVEL

All maintenance should be done as part of the normal servicing of the coach.

The oil level should be checked when the vehicle is first purchased and then once every two years. More often if there is an oil leak in the system.

All jacks and any HWH room extension cylinders should be completely retracted before checking the oil level. The oil reservoir is part of the pump/manifold assembly. The oil level is checked and filled through the breather cap. Clear any dirt away from the breather/filler cap before removing. The oil level should be within one inch of the top of the reservoir. Most breather caps have a dipstick.

NOTE: Overfilling the tank can cause leakage of oil through the breather cap.

FLUID: HWH Specialty Hydraulic Oil is recommended. In an emergency Dexron automatic transmission fluid can be used. **NOTE:** Dexron automatic transmission fluid contains red dye and can cause staining should a leak occur. **DO NOT USE** brake fluid or hydraulic jack fluid. Use of these can damage seals.

ELECTRICAL SYSTEM

The batteries should be in good condition and fully charged. Weak batteries can cause erratic operation. Battery cable terminals and battery posts and connections should be kept clean.

All electrical connections, especially ground connections, should be clean, tight, free from corrosion and protected from weathering.

JACKS

There are very few user serviceable parts on the jacks. The jacks require very little maintenance. If the jacks are extremely dirty with caked on mud they should be washed.

The jack rods should NOT be wiped and do not need to be oiled or sprayed with anything.

ROOM EXTENSIONS

The HWH room mechanisms need no maintenance. **DO NOT** grease or lubricate any parts of the HWH mechanism.

Any visible mechanism can be kept clean by washing with water. Refer to the vehicle manufacturer for correct maintenance of the room seals.

VISUAL INSPECTION

Periodically inspect the system for oil leaks and damaged or missing parts, such as pivot bolts or springs. Check the hydraulic lines and wiring for damage and wear. Check that the jacks do not interfere with any parts of the vehicle when they are in the "STORE" position.

The system will operate better if kept clean and free from caked on mud or ice.

OPERATIONAL CHECK

Review the OPERATOR MANUAL. Run the system according to the SYSTEM OPERATION Section. Note any abnormal operation.

Review the "JACK RETRACTION" Section. Make sure the jacks will fully retract to the "STORE" position. Jacks should not interfere with any of the coach when in the "STORE" position.

Check that all lights work according to the "INDICATOR LIGHT" Section. Correct function of the red "WARNING" light is important.

MAINTENANCE

SENSING UNIT ADJUSTMENT

Level the vehicle by placing a bubble level in the center of the freezer floor or upon whichever surface within the vehicle that is to be level. Using the Leveling System and the bubble level, ignoring the yellow LEVEL lights on the Touch Panel, level the vehicle until the bubble is centered.

With the vehicle level according to the bubble level, if there are no yellow lights lit on the Touch Panel, the sensing unit is properly adjusted. If there are yellow LEVEL lights lit on the Touch Panel, manual adjustments to the Sensing Unit are needed. A 7/8", 3/4" or 5/16" socket w/driver or box end wrench and a philips screw driver will be needed.

The Sensing Unit is mounted inside the Control Box. The Control Box is mounted to the power unit/valve assembly.

There are four LED's on the Sensing Unit, A,B,C and D. Refer to the drawing below. The Sensing Unit is adjusted by turning the adjustment nut to turn out LED's B and D. The adjustment screw will turn out LED's A and C. If the adjustment nut has to be turned more than 1/2 flat or the adjustment screw has to be turned more than 3/4 turn to turn the LED out, there may be a problem with the Sensing Unit or the mounting of the Control Box. If two LED's are on, it is best to make the B-D adjustments first, then hold the adjustment nut from moving while making the A-C adjustment.

NOTE: If opposing LED's are lit, there is a problem with the Sensing Unit.

If LED (A) is lit: Turn the adjustment screw **COUNTER CLOCKWISE** until the LED is off.

If LED (C) is lit: Turn the adjustment screw **CLOCKWISE** until the LED is off.

If LED (B) is lit: Turn the adjustment nut **COUNTER CLOCKWISE** until the LED is off.

If LED (D) is lit: Turn the adjustment nut **CLOCKWISE** until the LED is off.

IMPORTANT: When all 4 LED's are off, move the vehicle to an unlevel position so one or two yellow lights are on. Level the vehicle according to the yellow LEVEL lights. Recheck the level. If more adjustment is needed, **DO NOT** try to adjust the sensing unit until the yellow level lights go out, instead just "tweak" the sensing unit, ignoring the LED's on the sensing unit.

Example: After the initial adjustment and releveling the vehicle, the front is still low. This means the front yellow level light is turning off too soon. Determine which sensing unit light is the front light, A-B-C or D. Move the adjustment for that light very, very, slightly in the **OPPOSITE** direction that is given in the above instructions for LED's A, B, C, and D. This will allow

the front yellow light to stay on slightly longer to bring the front up more. Again, unlevel the vehicle then relevel the vehicle using the yellow level lights on the touch panel. Recheck with a level. Repeat the "tweaking" process until the system levels the vehicle properly.

ADJUSTMENT NUT (5/16")

ADJUSTMENT SCREW (Phillips or 1/4")

ADJUSTMENT NUT (7/8" or 3/4")

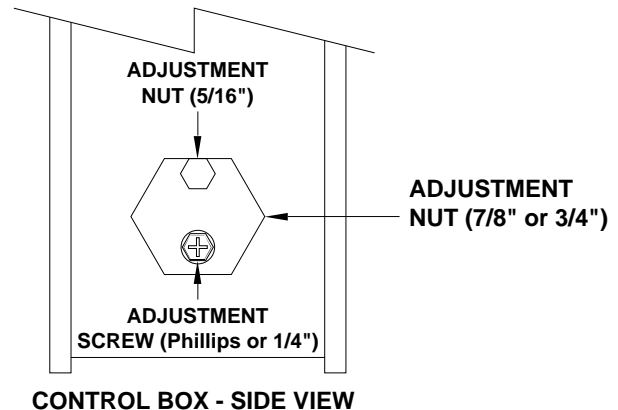
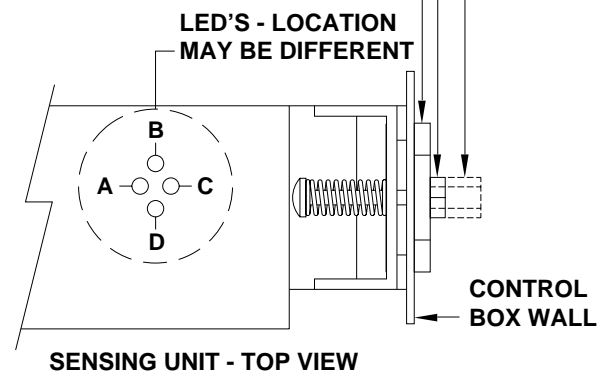

NOT IN PARK/BRAKE CHECK

CAUTION: WHEN MAKING THIS CHECK, BLOCK THE COACH WHEELS SECURELY SO THE COACH CANNOT ROLL FORWARD OR BACKWARD.

Set the park/brake. Switch the ignition to the "ACC" or "ON" position. Push the "ON/OFF" switch toward "ON". Release the parking brake and confirm that the "PARK" indicator light comes on. Reset the parking brake. The "PARK" indicator light should go out. Switch the ignition to "OFF".

If any of the above checks or inspections reveal a problem or if there are other problems or questions, consult a qualified RV repair center, your vehicle or coach manufacturer, or HWH CORPORATION for service or repair.

HYDRAULIC LINE CONNECTION DIAGRAM

625 SERIES LEVELING SYSTEM

(WITH 4 STRAIGHT-ACTING JACKS)

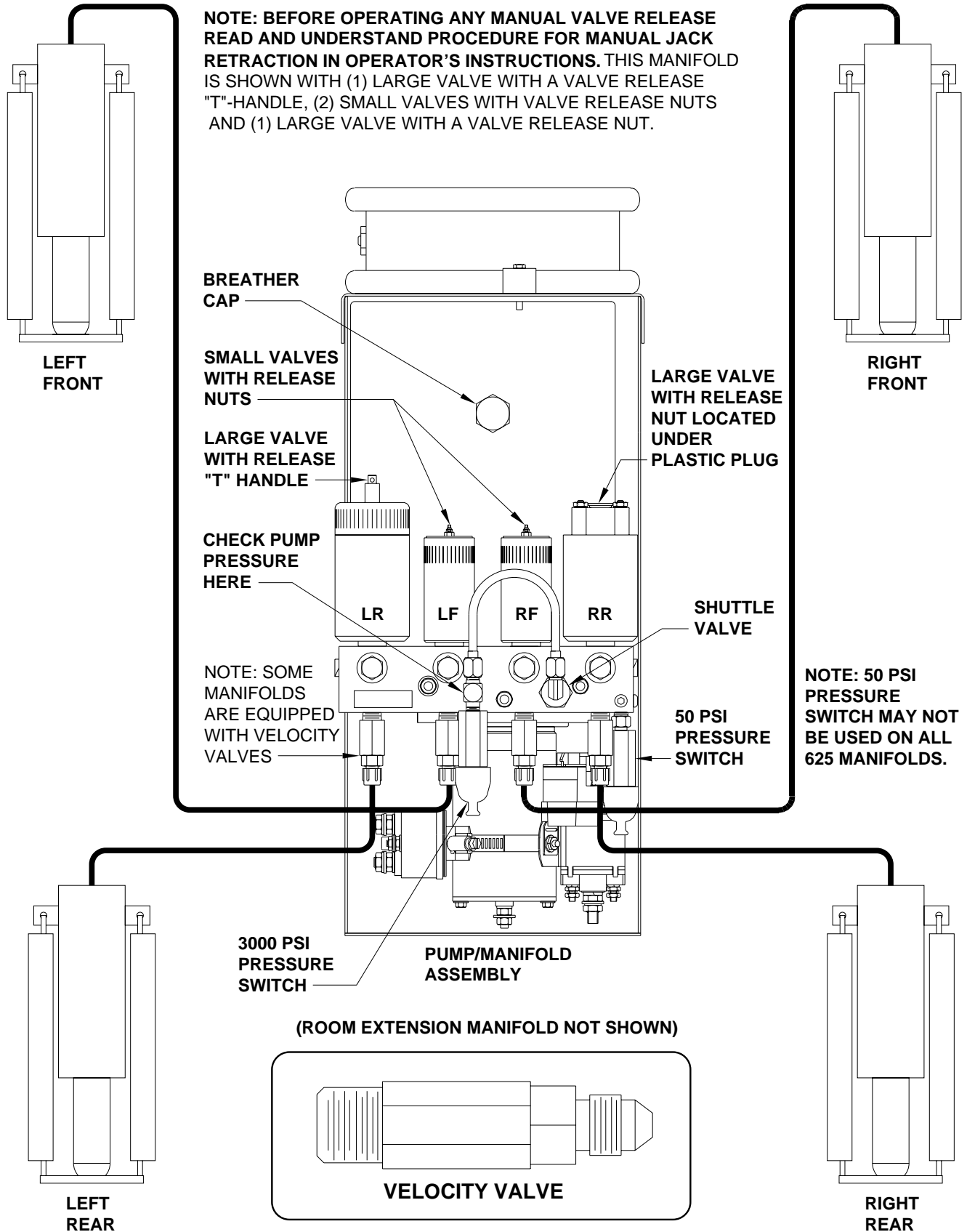

HYDRAULIC SCHEMATIC DIAGRAM

BI-AXIS LEVELING WITH STRAIGHT-ACTING JACKS

625 SERIES

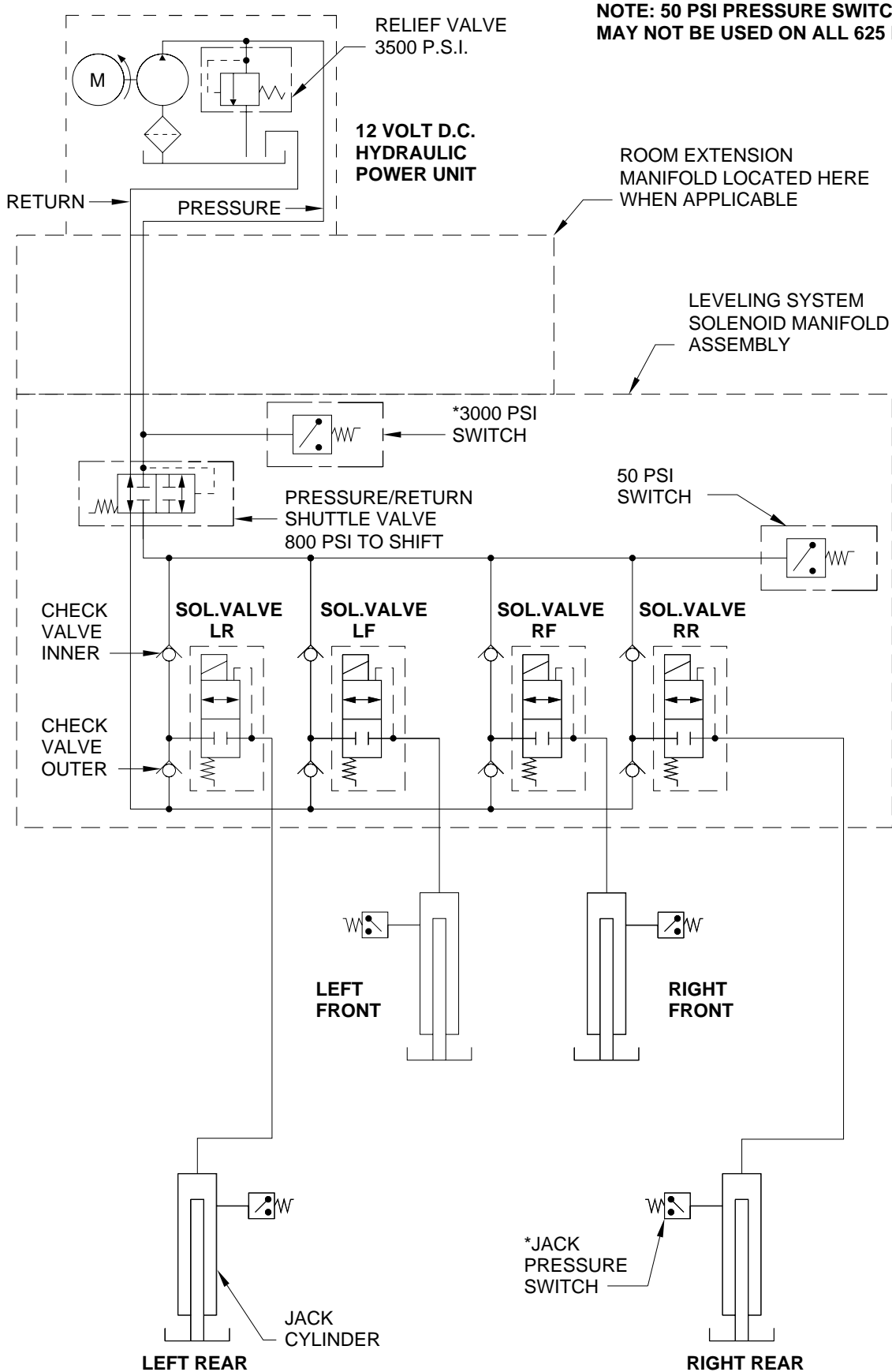

* USED ON AUTOMATIC SYSTEMS ONLY

MP65.601C
11APR08

BREATHER CAP - DIPSTICK - 1/4" NUT DRIVER

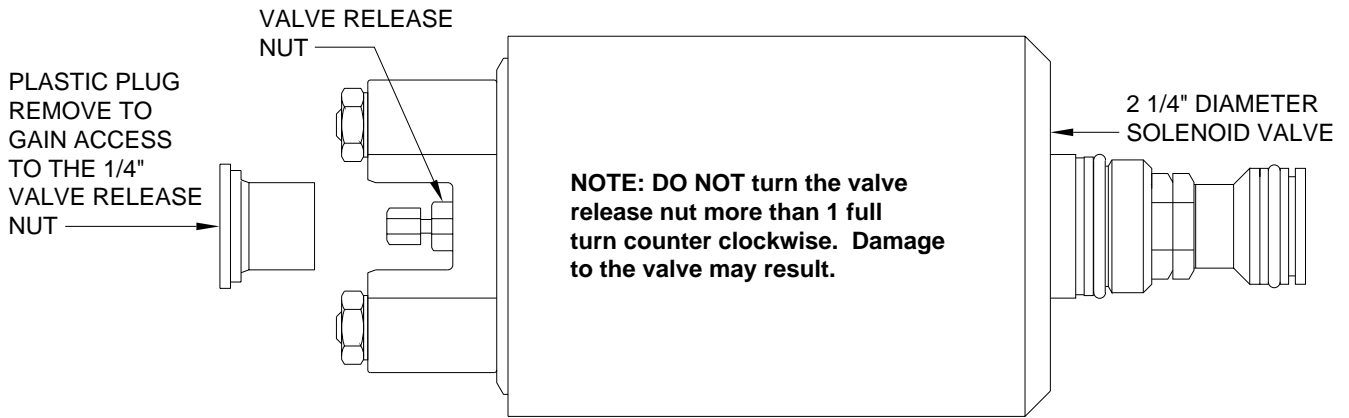
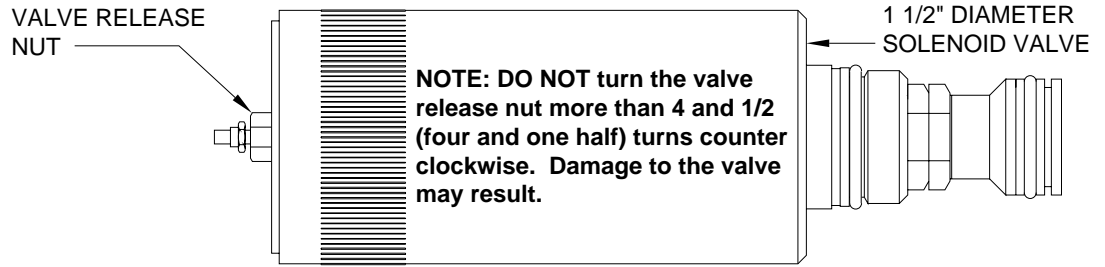

NOTE: THE BREATHER CAP IS LOCATED ON THE TOP SIDE OF THE POWER UNIT RESERVOIR.

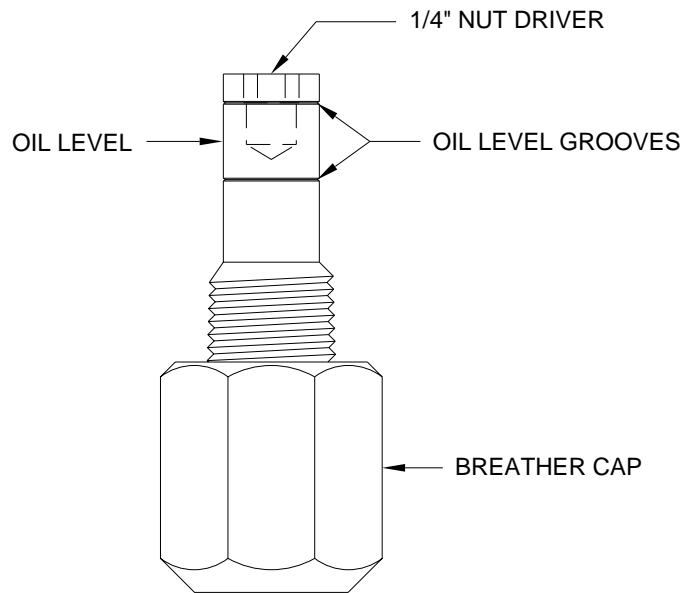

IMPORTANT: PRIOR TO REMOVING THE BREATHER CAP, EITHER TO CHECK THE OIL LEVEL OR TO USE THE 1/4" NUT DRIVER, CLEAN ANY DEBRIS FROM THE TOP OF THE RESERVOIR. BEFORE RETURNING THE BREATHER CAP TO THE RESERVOIR, REMOVE ANY PAINT CHIPS OR OTHER DEBRIS FROM THE DIPSTICK INCLUDING DEBRIS INSIDE THE 1/4" NUT DRIVER.