



# SERVICE MANUAL

## FOR MOTORIZED AND NON-MOTORIZED VEHICLES NO LEVELING SYSTEM SPACEMAKER® ROOM EXTENSION SYSTEMS

### FEATURING:

*Dual Cylinder "Rail" Room Extension (With Rack Sensing Valve)*  
*Single Cylinder Room Extension*

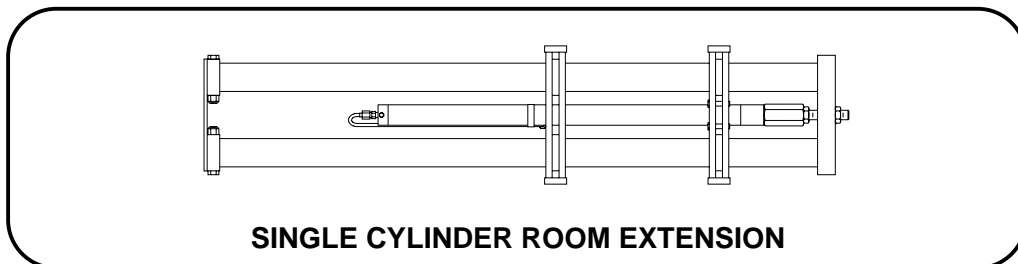
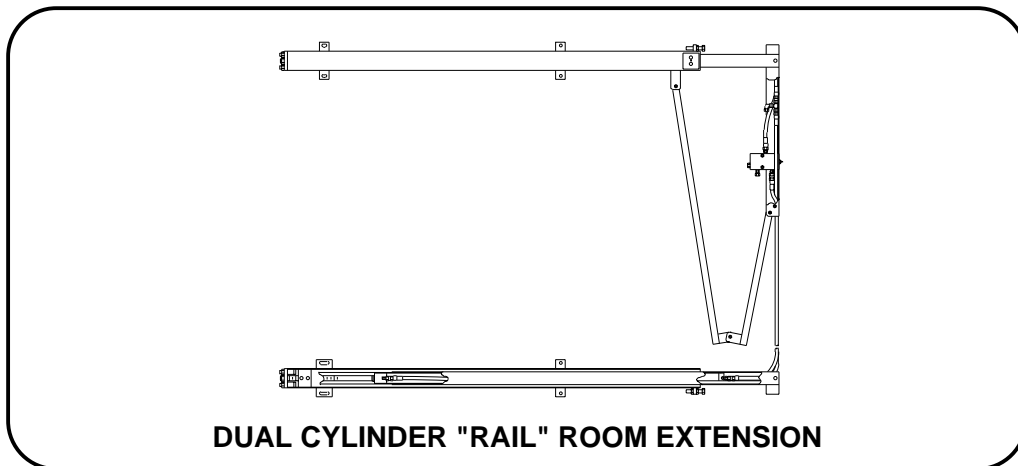

### HWH CORPORATION

(On I-80, Exit 267 South)

2096 Moscow Road | Moscow, Iowa 52760

Ph: 800/321-3494 (or) 563/724-3396 | Fax: 563/724-3408

[www.hwh.com](http://www.hwh.com)

ML11573/MI91.0007  
05MAY04

# SECTION 1

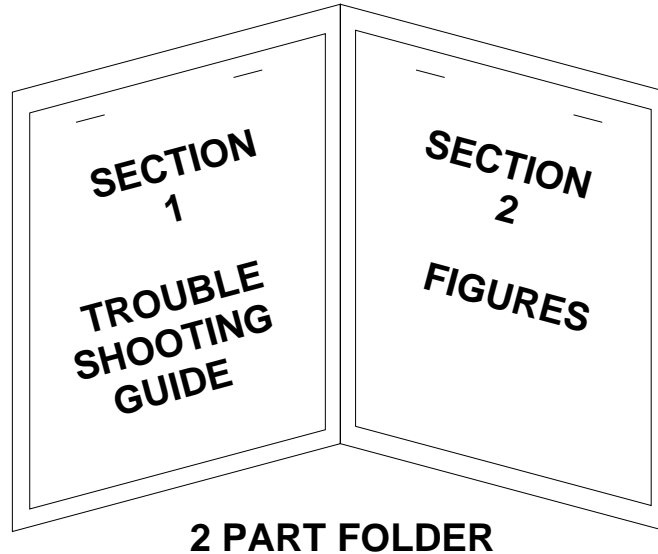

## HOW TO USE MANUAL

**NOTE:** This manual will work for systems with single cylinder room extensions also. The only difference is the exclusion of rack sensing valve problems or adjustments.

This manual is written in two sections. Section 1 is the Trouble Shooting Guide. Section 2 is the figures. Begin diagnosis of the system with Section 1, the Trouble Shooting Guide. The Trouble Shooting Guide is broken into 3 columns, Problem, Solutions and Figures. Under Problems, find the symptom you have encountered. The testing and repair for that problem is in the Solution (center) column. Diagrams for a particular Problem and Solution are in the Figures (right hand) column. This column will direct you to the proper figure in Section 2, Figures, for a more detailed view.

Before beginning your repair, it is IMPORTANT to read the CAUTIONS and NOTES AND CHECKS in the first section, TROUBLE SHOOTING GUIDE. In many cases this will save time and mistakes when trouble shooting a system.

This Repair Manual is offered as a guide only. It is impossible to anticipate every problem or combination of problems. For any problems encountered that are not addressed in this manual, contact HWH Corporation for assistance. (800-321-3494)

The room should be fully retracted before Trouble Shooting the system. If the room will not retract, use the manual retract procedure on pages MP35.9410 and MP35.9490.

**Make sure all room locks and the manual retract winch are not engaged before trouble shooting the system.**

**PROCEED WITH TROUBLE SHOOTING GUIDE**



# TROUBLE SHOOTING

## WARNING!

**BLOCK FRAME AND TIRES SECURELY BEFORE CRAWLING UNDER VEHICLE. DO NOT USE THE LEVELING JACKS OR AIR SUSPENSION TO SUPPORT VEHICLE WHILE UNDER VEHICLE OR CHANGING TIRES. VEHICLE MAY DROP AND OR MOVE FORWARD OR BACKWARD WITHOUT WARNING CAUSING INJURY OR DEATH.**

**WHEN ROUTING OR REROUTING HYDRAULIC HOSES AND WIRES, BE SURE THEY ARE NOT EXPOSED TO ENGINE EXHAUST OR ANY HIGH TEMPERATURE COMPONENTS OF THE VEHICLE.**

**NEVER PLACE HAND OR OTHER PARTS OF THE BODY NEAR HYDRAULIC LEAKS. OIL MAY CUT AND PENETRATE THE SKIN CAUSING INJURY OR DEATH.**

**SAFETY GLASSES ARE TO BE WORN TO PROTECT EYES FROM DIRT, METAL CHIPS, OIL LEAKS, ETC. FOLLOW ALL OTHER SHOP SAFETY PRACTICES.**

## NOTES AND CHECKS

Read and check before proceeding with Trouble Shooting Steps.

**NOTE: HWH CORPORATION ASSUMES NO LIABILITY FOR DAMAGES OR INJURIES RESULTING FROM THE INSTALLATION OR REPAIR OF THIS PRODUCT.**

1. If the room extension cannot be retracted, see Figures pages MP35.9410 and MP35.9490 for temporary measures. Make sure the manual retract valves are closed before trouble shooting.
2. Check that the oil reservoir is full with the room in the fully retracted position.
3. Batteries should read 12.6 volts. Batteries must be in good condition with no weak cells. An alternator, converter or battery charger will not supply enough power for the system to operate properly. Check between the positive and negative posts of the battery while the pump is running. This will check the battery condition under load.
4. Proper ground of all components is critical. See the electrical circuit for specific grounds required. Faulty grounds, especially for the solenoid manifold or the pump assembly, may cause component damage and /or improper or erratic operation.

This manual is intended for use by experienced mechanics with knowledge of hydraulic and automotive electrical systems. People with little or no experience with HWH Room Extension systems should contact HWH technical service (800-321-3494) before beginning. Special attention should be given to all cautions, wiring, and hydraulic diagrams.

**Tightening of hose ends:** If tightening a new hose end, make the hose end snug (finger tight) on the fitting, then tighten the hose end 1/3 turn (2 FLATS). If tightening an existing hose end, tighten the hose end to snug plus 1/4 turn (1 FLAT).

Suggested tools for trouble shooting the HWH room extension systems:

JUMPER WIRES (UP TO 10 GAUGE)  
PRESSURE GAUGE (3500 PSI MIN.)  
MULTI-METER  
12 VOLT TEST LIGHT

**PROCEED WITH THE TROUBLE SHOOTING STEPS ON THE FOLLOWING PAGE**



# TROUBLE SHOOTING

The following is a list of possible problems and solutions which might occur to room extensions. There will be only one power unit/valve assembly to operate the room extension(s). There will be one control panel for each room extension.

For some problems, trouble shooting may be different between motorized and non-motorized vehicles. Be sure to refer to the correct diagrams when needed.

**MOTORIZED VEHICLES :** To operate a room extension on a motorized vehicle, the ignition switch must be in the "ACC" position and the park brake must be set.

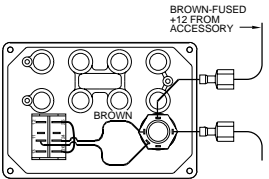
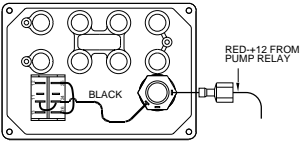
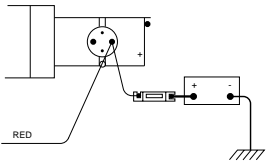
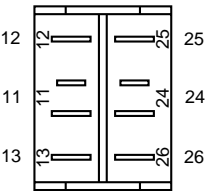
PROBLEM	SOLUTION	FIGURES
<p><b>Part 1</b>  <b>The pump will not run when the room extension switch is pushed toward EXTEND or RETRACT.</b></p>	<p style="text-align: center;"><b>Check that there is +12 power to key switch on the control panel.</b></p> <p style="text-align: center;"><b>MOTORIZED</b></p> <p>Check the brown wire going to the key switch. If there is no power, trace this wire to its source. This should be from the "ACC" side of the ignition switch.</p>	 <p style="text-align: center;"><b>REFER TO MP85.9415</b></p>  <p style="text-align: center;"><b>REFER TO MP85.9415</b></p>  <p style="text-align: center;"><b>REFER TO MP85.9420</b></p>
	<p style="text-align: center;"><b>NON-MOTORIZED</b></p> <p>Check the red wire going to the key switch. If there is no power at the switch, check the 15 amp fuse on the red wire at the pump relay. Check that there is power to the pump relay (Terminal 3) from the battery.</p>	<p><b>There is power to the key switch.</b> With the key switch on, check that there is power on Terminal 24 of the rocker switch. If there is no power, replace the control panel. If there is power on Terminal 24, check Terminals 25 and 26 while pushing the rocker switch toward EXTEND or RETRACT. If there is no power, replace the rocker switch.</p>  <p style="text-align: center;"><b>REFER TO MP85.9415</b></p>

# TROUBLE SHOOTING

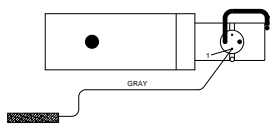
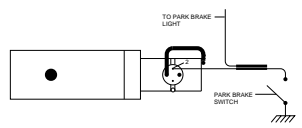
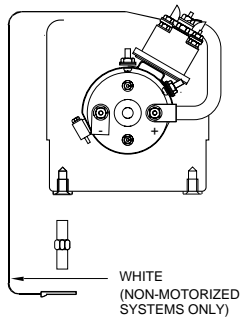
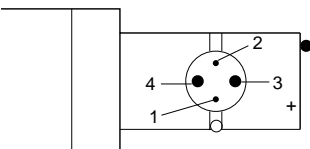
PROBLEM	SOLUTION	FIGURES
<p><b>Part 1 continued</b></p>	<p><b>There is power on Terminals 25 and 26 of the rocker switch.</b> Check for +12 on the gray wire on Terminal 1 of the pump relay. If there is no power, fix the gray wire.</p>	 <p style="text-align: center;"><b>REFER TO MP85.9420</b></p>
	<p>Check the relay ground on Terminal 2.</p> <p style="text-align: center;"><b>MOTORIZED</b></p> <p>The ground for the pump relay is supplied by the park brake switch. If there is no ground on Terminal 2, check that the park brake switch is set, then check the park brake circuit.</p>	 <p style="text-align: center;"><b>REFER TO MP85.9420</b></p>
	<p style="text-align: center;"><b>NON-MOTORIZED</b></p> <p>The ground for the relay is supplied by a wire going directly to the ground stud.</p>	 <p style="text-align: center;"><b>REFER TO M85.9430</b></p>
	<p><b>There is power to Terminals 1 and 3 of the pump relay and Terminal 2 is grounded.</b></p> <p>If there is power to Terminals 1 and 3 of the pump relay, there should be power on Terminals 4 and 5 when the rocker switch is pushed toward EXTEND or RETRACT. If power is not present replace the relay. If power is present, check that all connections are clean, tight and free from corrosion. If all connections are good, replace the pump.</p>	 <p style="text-align: center;"><b>REFER TO MP85.9420</b></p>

# TROUBLE SHOOTING

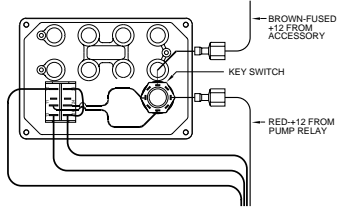
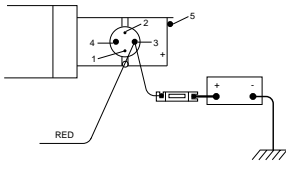
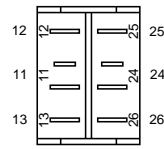
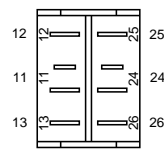
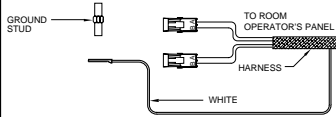
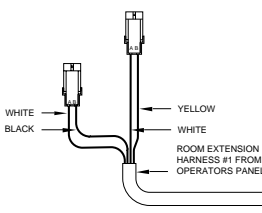
PROBLEM	SOLUTION	FIGURES
<p><b>Part 2</b>  <b>The pump runs but the room will not extend or retract. The pump seems to be dead heading.</b></p>	<p><b>MOTORIZED</b></p>	
	<p>Check that there is power to the control panel key switch on the red wire. If there is no power, check the fuse on the red wire at the pump relay. Check that there is power to the pump relay (Terminal 3) from the battery.</p> <p>If there is power to the key switch, with the key switch on, check for power on Terminal 11 of the rocker switch. If there is no power on Terminal 11, the key switch is bad, replace the panel.</p> <p><b>NOTE :</b> Some systems are wired with the red wire to Terminal 4 of the pump relay and will have power only when the pump is running.</p>	 <p style="text-align: center;"><b>REFER TO MP85.9415</b></p>  <p style="text-align: center;"><b>REFER TO MP85.9420</b></p>
	<p><b>NON-MOTORIZED</b></p>	
	<p>Power to operate the solenoid valves is the same power that turns the pump on. If the pump will run, Terminal 11 of the rocker switch should have power.</p>	 <p style="text-align: center;"><b>REFER TO MP85.9415</b></p>
	<p><b>Terminal 11 of the rocker switch has power.</b> Push the rocker switch to EXTEND to check Terminal 12 and RETRACT to check Terminal 13. If no power is present on either Terminal while pushing the switch, replace the rocker switch</p>	 <p style="text-align: center;"><b>REFER TO MP85.9415</b></p>
	<p><b>The rocker switch is functioning properly.</b> Check that there is continuity between the A Terminal of the room extension harness solenoid valve plug and ground. Check the connection of the white wires to the ground stud.</p>	 <p style="text-align: center;"><b>REFER TO MP85.9430</b></p>
	<p>Check for +12 on the B Terminal of the harness plug. Check the plug with the yellow wire if pushing the rocker switch toward EXTEND. Check the plug with the black wire if pushing the rocker switch toward RETRACT. If +12 is not present replace the harness wire. If +12 is present replace the solenoid valve.</p>	 <p style="text-align: center;"><b>REFER TO MP85.9425</b></p>

# TROUBLE SHOOTING

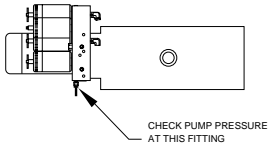
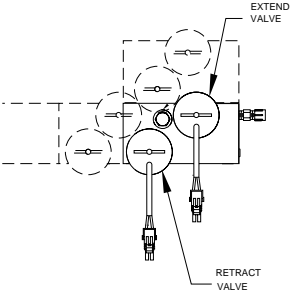
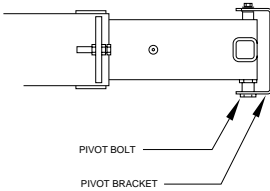
PROBLEM	SOLUTION	FIGURES
<p><b>Part 3</b> The pump will come on but is free wheeling.</p>	<p>Make sure the valve release "T" handles are closed. (Turn clockwise) With the room(s) fully retracted check that the tank is full of fluid.</p> <p><b>If trying to extend</b>, the retract valve could be open. Unplug the retract valve. If the problem stops, replace the rocker switch. If the problem continues, check the pump pressure while pushing the switch toward RETRACT. If there is no pressure, replace the pump. If there is good pressure, replace the retract solenoid valve.</p> <p><b>NOTE :</b> The pump should develop 3500 psi.</p> <p><b>If trying to retract</b>, the extend valve could be open. Unplug the extend valve. If the problem stops, replace the the rocker switch. If the problem continues, check the pump pressure while pushing the switch toward EXTEND. If there is no pressure, replace the pump. If there is good pressure, replace the extend solenoid valve.</p>	 <p style="text-align: center;"><b>REFER TO MP65.9415</b></p>  <p style="text-align: center;"><b>REFER TO MP85.9425</b></p>
<p><b>Part 4</b> The room moves erratically from side to side (walking) as it extends or retracts (dual cylinder room extensions only.)</p> <p><b>IMPORTANT :</b> An adjustment will not fix this problem.</p>	<p>Check that the pivot bracket is free to pivot. Check that the inner tubes are free of paint or undercoating. Check that the left cylinder hydraulic lines are not wire tied to the room closer than 12 inches to the rack sensing valve support arm. (SEE MP45.9415)</p> <p>Check that the strike plate is mounted solidly to the room, and that the rack sensing valve plunger is properly positioned on the strike plate. Check that the plunger is not bent. (SEE MP35.9410) Check that the room itself is not binding on seals or other interferences. Then replace the rack sensing valve. (SEE MP45.9420)</p>	 <p style="text-align: center;"><b>REFER TO MP45.9415</b></p>
<p><b>Part 5</b> The ends of the room do not move at an equal distance from the vehicle.</p>	<p>The rack sensing valve needs to be adjusted. See MP45.9420 for valve adjustment procedures.</p>	

# TROUBLE SHOOTING

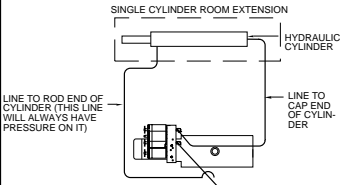
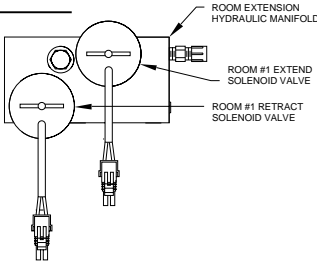
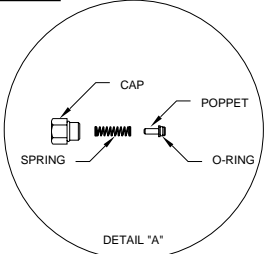
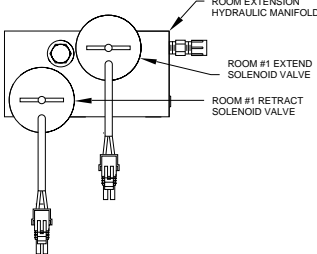
PROBLEM	SOLUTION	FIGURES
<p><b>Part 6</b> The room creeps out after being retracted.</p>	<p>The following deals with either single or dual cylinder room extensions. There are three possibilities:</p> <ul style="list-style-type: none"> <li>A. An extend solenoid valve is leaking.</li> <li>B. A room extension cylinder has an internal leak.</li> <li>C. The manifold check valve is leaking.</li> </ul> <p><b>NOTE :</b> If the room creeps out 1 or 2 inches or less the problem is most likely the check valve.</p> <p>Retract the room completely. Remove the hydraulic line for the cap end of the cylinder at the manifold. Hold the line with the hose end in an upright position. Press the rocker switch for that room to the RETRACT position.</p>	 <p style="text-align: center;"><b>REFER TO MP65.9415</b></p>
	<p>If fluid flows from the manifold fitting, the extend solenoid valve needs to be changed.</p>	 <p style="text-align: center;"><b>REFER TO MP85.9425</b></p>
	<p>If fluid flows from the hose end, the room extension cylinder should be replaced.</p>	
	<p>If no fluid flows from either the hose end or the manifold fittings, inspect the manifold check valve. There is a spring below the cap. DO NOT lose the spring. Check for cuts on the poppet o-ring. Check the poppet and cap for burrs. The poppet should easily slide in the cap. If the check valve is OK, the problem is most likely the cylinder.</p>	 <p style="text-align: center;"><b>REFER TO MP85.9425</b></p>
	<p>To replace a single cylinder room extension cylinder, see MP45.9412.</p>	
	<p>To replace a dual cylinder room extension cylinder, see MP45.9415.</p>	
<p><b>Part 7</b> The room creeps back in after being extended.</p>	<p>Replace the retract solenoid valve for that room extension. This is the only possibility that would cause this problem.</p>	 <p style="text-align: center;"><b>REFER TO MP85.9425</b></p>

# TROUBLE SHOOTING

PROBLEM	SOLUTION	FIGURES
<b>Part 8</b> <b>The room does not seal tightly when fully retracted or extended.</b>	For single cylinder room extensions see the adjustment section of MP45.9412.  For dual cylinder room extensions see the adjustment section of MP45.9415.	

## CONTROL IDENTIFICATION

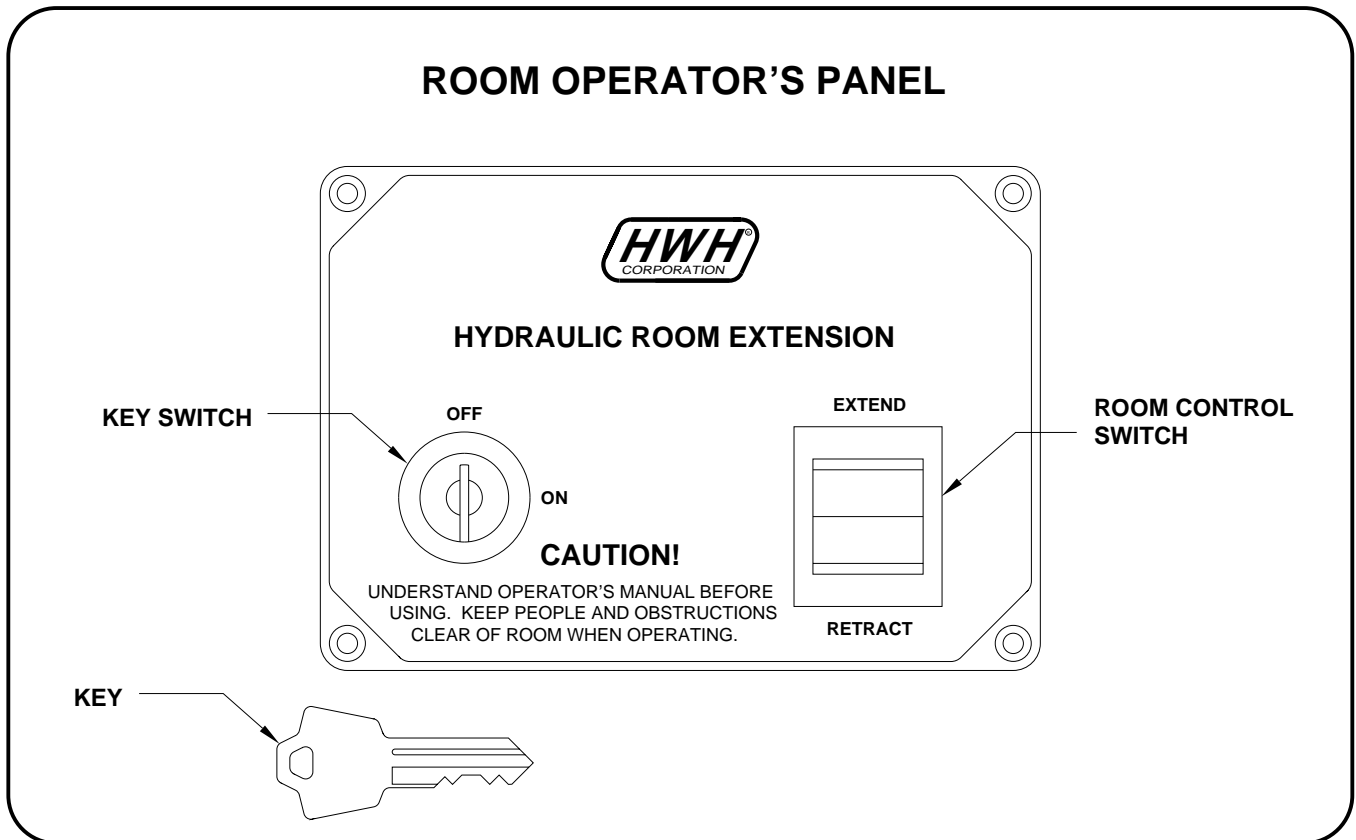

## CONTROL FUNCTIONS

**KEY SWITCH:** The KEY SWITCH controls power to the ROOM CONTROL SWITCH. When the KEY SWITCH is in the "ON" POSITION the room can be operated, and the key cannot be removed. When the KEY SWITCH is in the "OFF" position the room cannot be operated, and the key can be removed.

**ROOM CONTROL SWITCH:** The ROOM CONTROL SWITCH is a two position momentary switch. Pressing the switch in the EXTEND POSITION will extend the room. Pressing the switch in the RETRACT POSITION will retract the room. Releasing the ROOM CONTROL SWITCH will halt the operation of the room.

**MANUAL ROOM RETRACT PROCEDURE**  
**USE ONLY WHEN ROOM CANNOT BE RETRACTED WITH THE ROOM CONTROL SWITCH OR THE MANUAL RETRACT WINCH.**  
**THIS SHOULD BE DONE BY A CERTIFIED TECHNICIAN ONLY.**  
**CONTACT HWH CORPORATION FOR ASSISTANCE AT (1-800-321-3494).**

When extending or retracting the room, if one side of the room does not move, release the room control switch immediately. The rack sensing valve plunger (1, FIGURE 1) may be stuck, bent or not touching the strike plate (2, FIGURE 1).

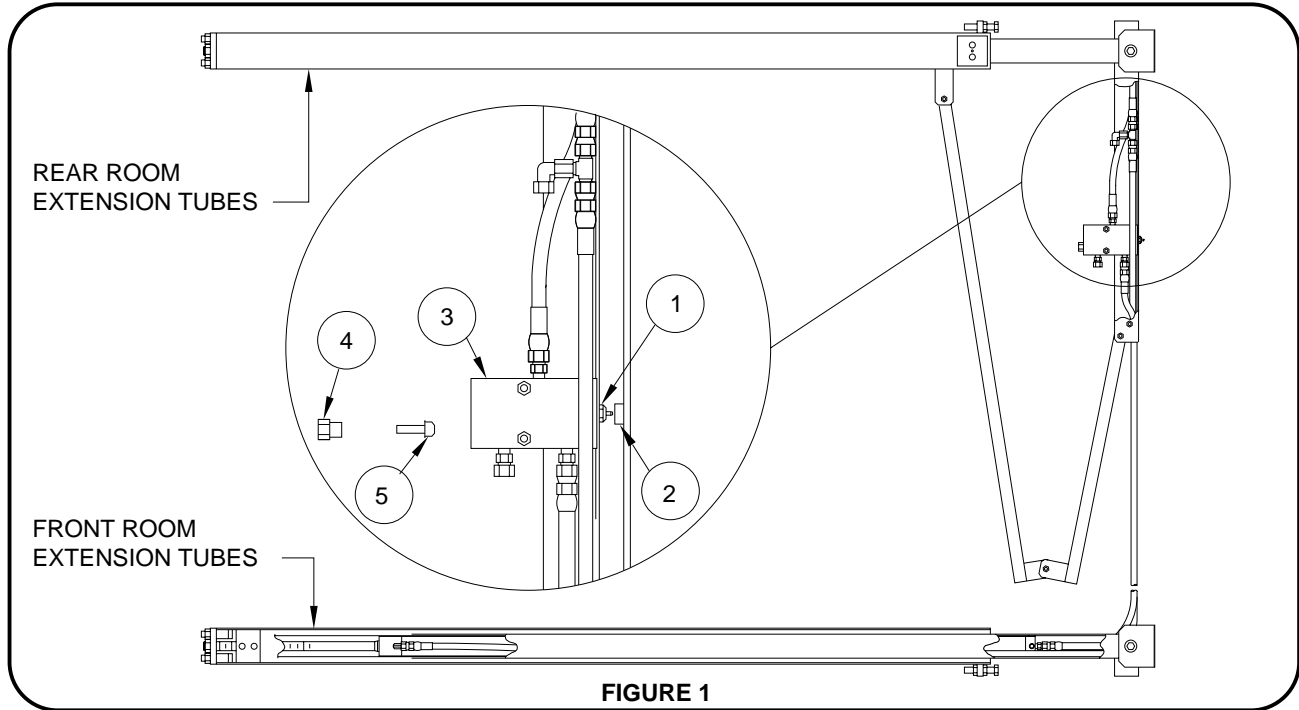
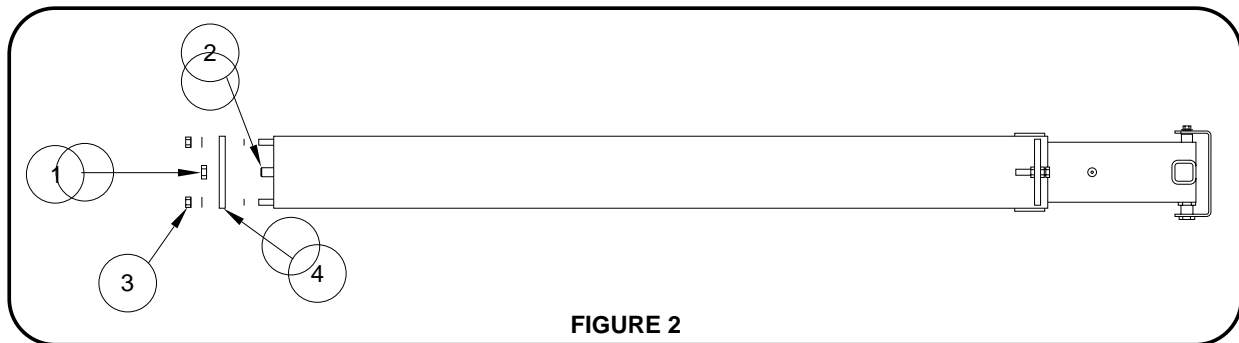

**FIGURE 1**

**ROOM IN EXTENDED POSITION**

Refer to page MP35.9490 in the Operator's Manual or the repair manual, and try to manually retract the room, if it is extended. If the manual winch provided will not retract the room, **DO NOT USE ALTERNATE DEVICES SUCH AS A POWER WINCH.** If possible repair the rack sensing valve (3, FIGURE 1) before retracting the room. If repair is not possible, release the pressure on the manual retract winch. Remove the check valve cap (4, FIGURE 1) from the back of the rack sensing valve. Remove the check valve poppet (5, FIGURE 1). Replace the check valve cap. Retract the room using the manual retract winch according to MP35.9490. **DO NOT** use the room extension until the rack sensing valve has been replaced. Leave the manual winch in place and have the room extension repaired.

**CAUTION :** ROOM EXTENSION SOLENOID VALVE "T" HANDLES MUST BE IN THE OPEN POSITION WHEN THE MANUAL RETRACT WINCH IS CONNECTED. **DO NOT** USE THE ROOM EXTENSION OR LEVELING SYSTEM WHEN THE ROOM EXTENSION HYDRAULIC HOSES ARE DISCONNECTED.



**FIGURE 2**

**ROOM IN RETRACTED POSITION**

If one side of the room will not move while extending, repair the rack sensing valve before continuing. Remove the cylinder adjusting locknut (1, FIGURE 2). Turn the cylinder adjusting rod (2, FIGURE 2) clockwise as far as possible. If this is not enough room to work on the valve, remove the cylinder mounting plate nuts (3, FIGURE 2) and the cylinder mounting plate (4, FIGURE 2). The room can then be pulled out far enough to work on the rack sensing valve. Contact HWH Corporation, 1-800-321-3494, for the correct rack sensing valve and cylinder replacement and adjustment instruction sheets.

# MANUAL ROOM RETRACT PROCEDURE (WITH SOLENOID VALVES WITH VALVE RELEASE "T" HANDLES)

(USE ONLY WHEN THE ROOM WILL NOT RETRACT WITH THE ROOM CONTROL SWITCH)

## OVERVIEW

The room can be retracted manually if a hydraulic or electrical failure prevents the room from being retracted using the ROOM CONTROL SWITCH. For normal retract sequence see the ROOM RETRACT PROCEDURE.

**CAUTION:** THE MANUAL RETRACT WINCH IS EQUIPPED FOR MANUALLY RETRACTING THE ROOM ONLY. IT IS NOT TO BE USED FOR LIFTING OR ANY OTHER APPLICATION. HIGH FORCES ARE CREATED WHEN USING A WINCH, CREATING POTENTIAL SAFETY HAZARDS. FAILURE TO FOLLOW ALL CAUTIONS AND INSTRUCTIONS MAY CAUSE FAILURE OF THE MANUAL RETRACT WINCH OR CONNECTIONS RESULTING IN DAMAGE OR PERSONAL INJURY. MAINTAIN FIRM GRIP ON THE WINCH HANDLE AT ALL TIMES. NEVER RELEASE THE HANDLE WHEN RATCHET LEVER IS IN THE OFF POSITION AND THE WINCH IS LOADED. THE WINCH HANDLE COULD SPIN VIOLENTLY AND CAUSE PERSONAL INJURY. CHECK THE WINCH AND STRAPS FOR DAMAGE OR WEAR, AND CHECK FOR PROPER RATCHET OPERATION ON EACH USE OF THE WINCH. DO NOT USE IF DAMAGED OR WORN.

1. Retract jacks following the LEVELING SYSTEM RETRACT PROCEDURE.

**NOTE :** When manually retracting the room, make sure the jacks are retracted before retracting the room.

2. Locate the HYDRAULIC PUMP/MANIFOLD unit.

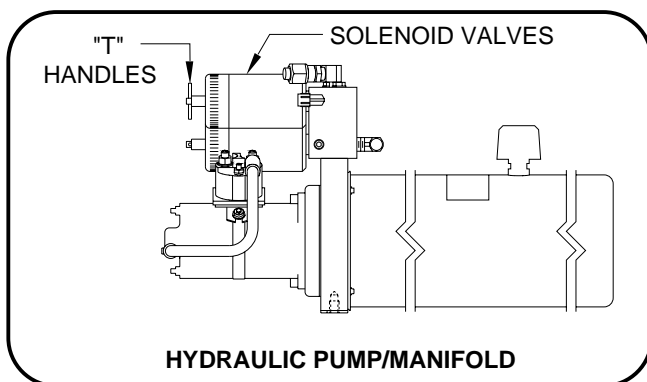

3. Open the SOLENOID VALVES by turning the "T" HANDLES counterclockwise.

**NOTE :** The "T" HANDLE may turn easily at first but will become more difficult to turn as an internal spring is compressed. Be sure to open both valves completely (about six turns of "T" HANDLE).

**NOTE :** The room may move slightly as the SOLENOID VALVES are opened and internal pressure is released.

4. Locate the MANUAL RETRACT WINCH and connect it to the room according to the vehicle manufacturer's instructions. To extend the WINCH STRAP firmly grasp WINCH HANDLE, place RATCHET LEVER in its OFF position, and slowly rotate the WINCH HANDLE counterclockwise, keeping a firm grip on the handle. When enough WINCH STRAP is extended, place the RATCHET LEVER in its ON position and slowly rotate the WINCH HANDLE clockwise until the RATCHET LEVER locks.

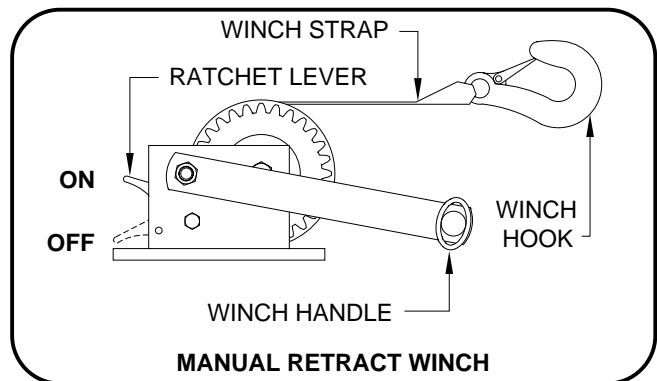

5. Slowly winch the room in by turning the WINCH HANDLE clockwise. The RATCHET LEVER should produce a loud, sharp, clicking noise.

**NOTE :** Winching the room in quickly will raise pressure in the hydraulic fluid and make winching more difficult.

**CAUTION:** OPERATE THE MANUAL RETRACT WINCH BY HAND POWER ONLY. IF THE WINCH CANNOT BE CRANKED EASILY WITH ONE HAND IT IS PROBABLY OVERLOADED. IF WINCHING BECOMES TOO DIFFICULT STOP AND CHECK FOR OBSTRUCTIONS OR RESTRICTIONS ON THE ROOM AND ROOM EXTENSION MECHANISM.

6. When the room is fully retracted, engage the room locking devices. Leave the retract winch in place.

**CAUTION:** THE ROOM EXTENSION SOLENOID VALVE "T" HANDLES MUST BE IN THE OPEN POSITION WHEN THE MANUAL RETRACT WINCH IS ENGAGED.

7. The system should be repaired before using again.



**READ  
INSTRUCTIONS  
THOROUGHLY  
BEFORE  
PROCEEDING**

## CYLINDER REPLACEMENT ROOM EXTENSION ASSEMBLY SINGLE CYLINDER ROOM EXTENSION

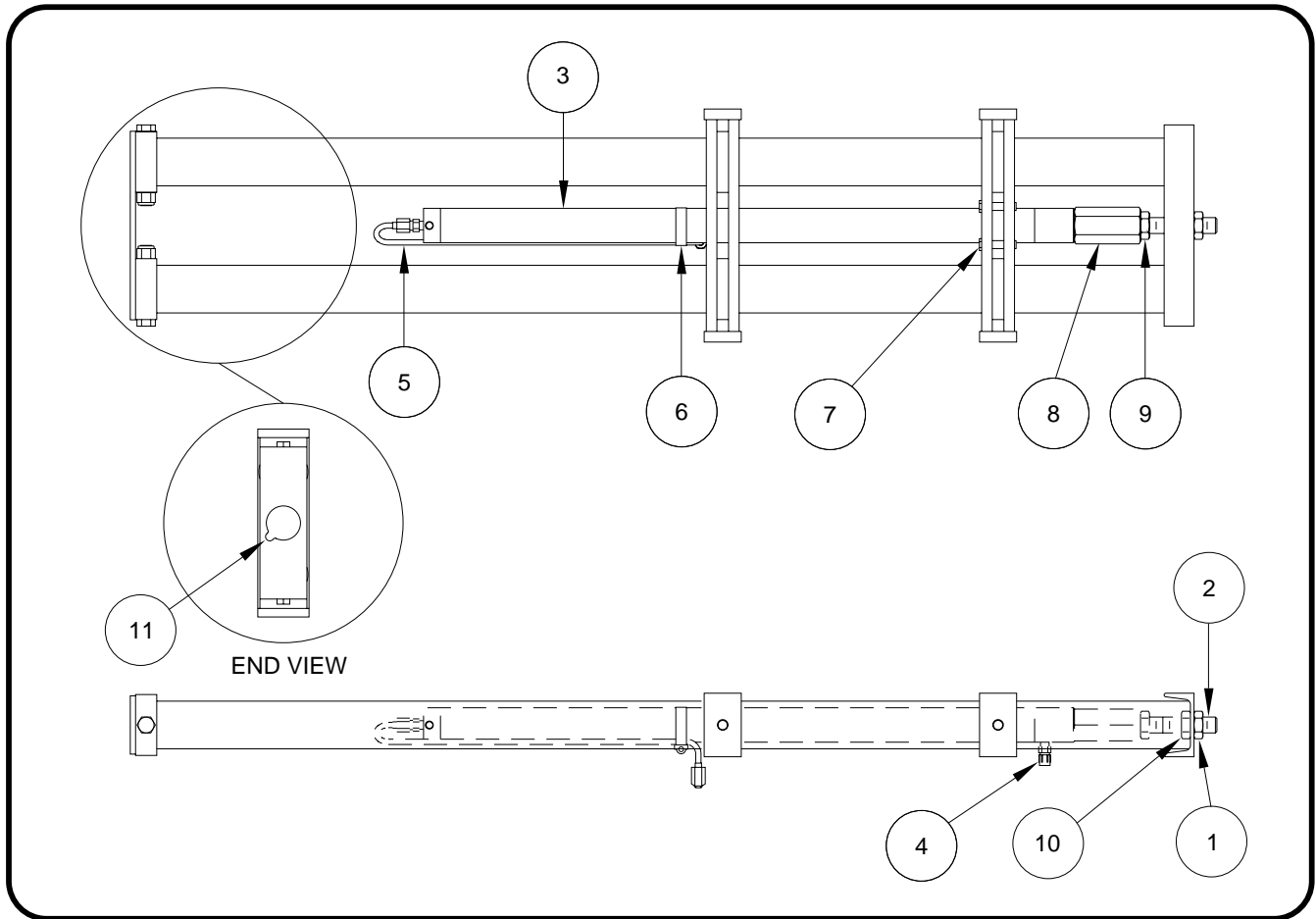

### CYLINDER REPLACEMENT

Extend the room completely. Remove the outer adjusting nut (1). Open the extend and retract room extension solenoid valve release T-handles. Push the rod (2) completely back into the cylinder. Remove and plug the hose from the front of the cylinder (4). Cap the fitting. Remove the band clamp (6). Remove and plug the tube from the rear of the cylinder (5). Cap the fitting. Remove the four cylinder mounting bolts (7). Remove the cylinder assembly (3) from the room extension. The new cylinder is supplied with the stop nut and lock nut, (8 & 9) and the two adjusting nuts (1 & 10). Measure the distance between the end of the cylinder rod (2) and the adjusting nut (10) on the old cylinder assembly and add 1/4 inch. Set the adjusting nut (10) for the new cylinder assembly at that distance. Measure the distance between the end of the cylinder rod (2) and the stop nut (8) on the old cylinder assembly and add 1/4 inch. Set the stop nut (8) for the new cylinder assembly at that distance. Replace the cylinder and tighten the four cylinder mounting bolts (7). Attach the hose (4), the tube (5) and the band clamp (6). DO NOT over tighten hose fittings. Make sure the tube will pass freely through the notch in the rear tube support (11). Pull the rod out and reattach to the room with the adjusting nut (1).

**Tightening of hose ends: If tightening a new hose end, make the hose end snug (finger tight) on the fitting, then tighten the hose end 1/3 turn (2 FLATS). If tightening an existing hose end, tighten the hose end to snug plus 1/4 turn (1 FLAT).**

Run the room in and out several times and check for leaks. Adjust the out stop using the adjusting nuts (1 & 10) until the room extension seals are properly compressed. Adjust the in stop by turning the stop nut (8) in or out until the seals are properly compressed. Tighten jam nut (9) against stop nut (8).

**Clean any oil spills from the room area.**

**IMPORTANT: Watch carefully that the room does not extend too far when operating the room the first time after replacing the cylinder.**

# CYLINDER REPLACEMENT ROOM EXTENSION ASSEMBLY DUAL CYLINDER ROOM EXTENSION

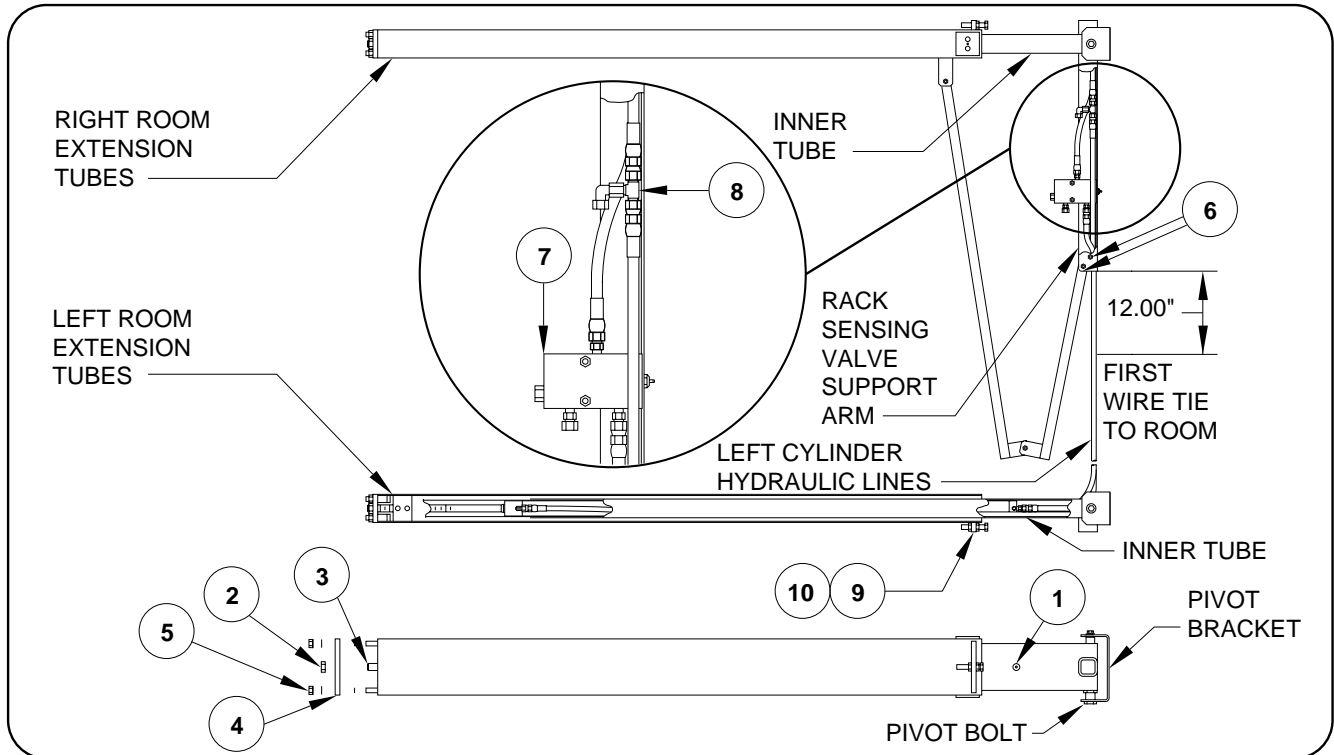

## CYLINDER REPLACEMENT

Extend the room until the cylinder mounting bolts (1) are visible. Make sure there is adequate room to work with the hose connections at the rack sensing valve. Open the extend and retract room extension solenoid valve "T" handles. Remove the cylinder adjusting lock nut (2). Measure the distance between the end of the cylinder adjusting rod (3) and the cylinder mounting plate (4). Add 1/4 inch to that measurement, this will allow for easy adjustment of the room after installing the new cylinder. Remove the two hose guide mounting bolts (6). (this is not necessary when removing the right cylinder). Remove the cylinder hoses from the sensing valve (7) and the tee fitting (8). Plug the hose ends and tie a wire to the two hoses, this will help when feeding the hoses back through the room extension tubes. Remove the cylinder mounting plate mounting nuts (5). Remove the cylinder assembly. **Before installing the new cylinder, clean all excess oil from the extension tubes. Swab the tube thoroughly with mild solvent and rags. Excess oil left in the tubes may leak giving the appearance of a leaky room cylinder or hose connection.**

Pull the rod out of the new cylinder approximately 1 1/2 feet. Some fluid will come out of the fittings. Move the hoses from the old cylinder to the new cylinder. **DO NOT** over tighten the fittings. Move the cylinder mounting plate to the new rod. Use the measurement from the old rod. Feed the hoses and new cylinder into the extension tube. Line up the cylinder mounting holes and replace the cylinder bolts (1). Reattach the hoses and hose guide. Push the rod in and attach the cylinder mounting plate. Close the room extension solenoid valves. Purge the air from the system by using the following steps. Retract the room completely. Extend the room 1 foot then retract the room completely. Extend the room 2 feet then retract the room completely. Extend the room fully then retract the room completely. Extend the room fully and hold the button toward extend for 5 seconds. Check for leaks. After replacement is complete check oil level in the tank.

**Tightening of hose ends:** If tightening a new hose end, make the hose end snug (finger tight) on the fitting, then tighten the hose end 1/3 turn (2 FLATS). If tightening an existing hose end, tighten the hose end to snug plus 1/4 turn (1 FLAT).

## CYLINDER ADJUSTMENT

Extend the room completely. Turn the cylinder adjustment rod (3) in or out until the room seals are properly compressed. Replace and tighten the cylinder adjusting lock nut (2). The in stop is adjusted by loosening the lock nut (9) and turning the adjusting nut (10) in or out until the seals are properly compressed. This adjustment should not have to be changed after replacing the cylinder.

**IMPORTANT:** Watch carefully that the room does not rack excessively or extend too far when operating the first time after replacing the cylinders.



**READ  
INSTRUCTIONS  
THOROUGHLY  
BEFORE  
PROCEEDING**

## ROOM EXTENSION RACK SENSING VALVE REPLACEMENT / ADJUSTMENT

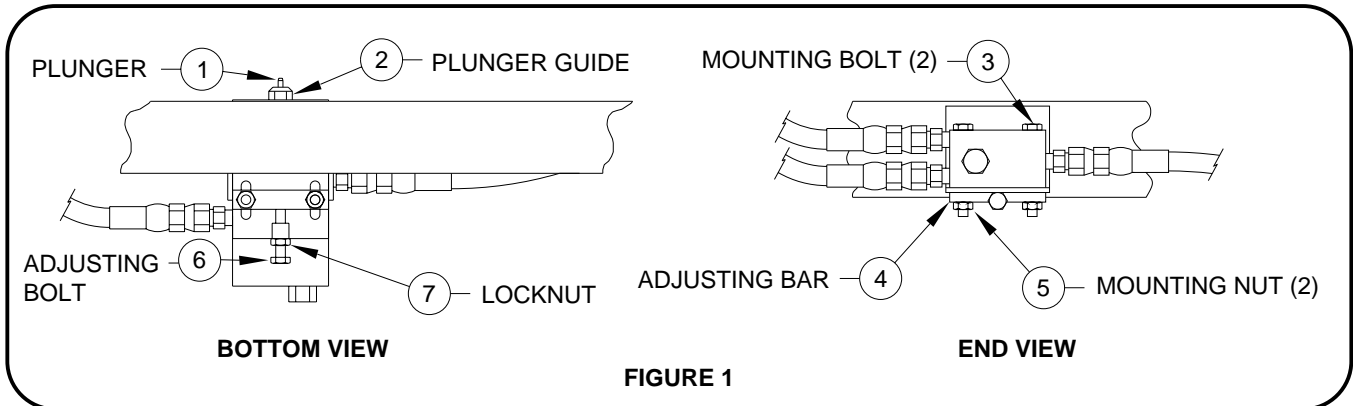

### REPLACEMENT

When replacing a rack sensing valve, the valve release "T" handles for both valves on the room extension manifold must be opened (counter clockwise) five to six turns to relieve pressure on the system. Only two solenoid valves for that room extension need to be opened.

Loosen the rack sensing mounting bolts. (3 & 4, FIGURE 1)  
Remove the adjusting bolt and lock nut. (6 & 7, FIGURE 1)  
Remove the three hydraulic lines from the valve. Remove the mounting bolts and valve adjusting bar. (5, FIGURE 1)  
Replace the valve but do not tighten the mounting bolts.  
Replace the hydraulic lines and the adjusting bolt and lock nut.

Adjust the valve so that approximately one half the plunger (1, FIGURE 1) is showing. Close the valve release "T" handles. Make the final adjustment of the rack sensing valve. (See the ADJUSTMENT procedure below). Tighten the mounting bolts and check for leaks and the fluid level in the power unit.

**Tightening of hose ends: If tightening a new hose end, make the hose end snug (finger tight) on the fitting, then tighten the hose end 1/3 turn (2 FLATS). If tightening an existing hose end, tighten the hose end to snug plus 1/4 turn (1 FLAT).**

### ADJUSTMENT

Extend the room 6 inches then retract. Do this several times to remove air from the system. Extend the room approximately 6 inches. Both sides of the room should move at an equal distance from the vehicle. **If the difference is approximately 1/2 inch or less do not adjust the valve.** The movement of the room can be adjusted by moving the

rack sensing valve in or out using the valve adjusting bolt. (6, FIGURE 1) Loosen the rack sensing valve mounting bolts (3&5, FIGURE 1) and the adjusting lock nut. (7, FIGURE 1) Do not tighten these until the adjustment is complete. Refer to FIGURE 2 or 3 depending on which side of the room is leading, for the proper adjustment of the valve.

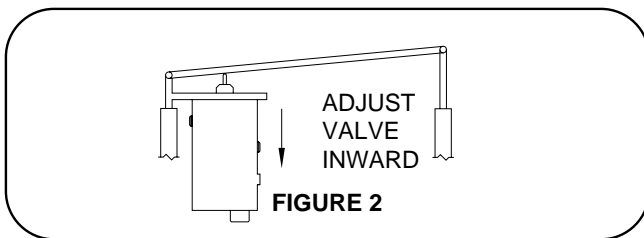

If the valve side of the room is moving at a closer distance to the vehicle (FIGURE 2) turn the adjusting bolt (6, FIGURE 1) counter clockwise 1 turn. **NOTE** : If the difference is minor, less than 1 turn may be appropriate. Extend the room an additional 12 inches. Retract the room that 12 inches and check the measurement. Repeat this procedure as necessary. The difference in the measurement should be 1/2 an inch or less. Tighten the mounting bolts and adjusting lock nut when the adjustment is complete.

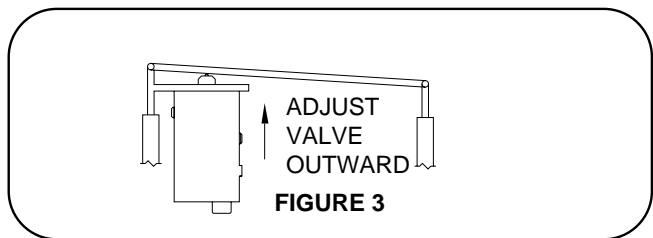

If the valve side of the room is moving at a greater distance from the vehicle (FIGURE 3) turn the adjusting bolt clockwise 1 turn. **NOTE** : If the difference is minor, less than 1 turn may be appropriate. Extend the room an additional 12 inches. Retract the room that 12 inches and check the measurement. Repeat this procedure as necessary. The difference in the measurement should be 1/2 an inch or less. Tighten the mounting bolts and adjusting lock nut when the adjustment is complete.

**REMEMBER** : If the room is racking from side to side while moving, adjusting the rack sensing valve will not fix the problem.



# HYDRAULIC SCHEMATIC DIAGRAM

## SINGLE CYLINDER ROOM EXTENSION AND

### DUAL CYLINDER ROOM EXTENSION W/RACK SENSING VALVE

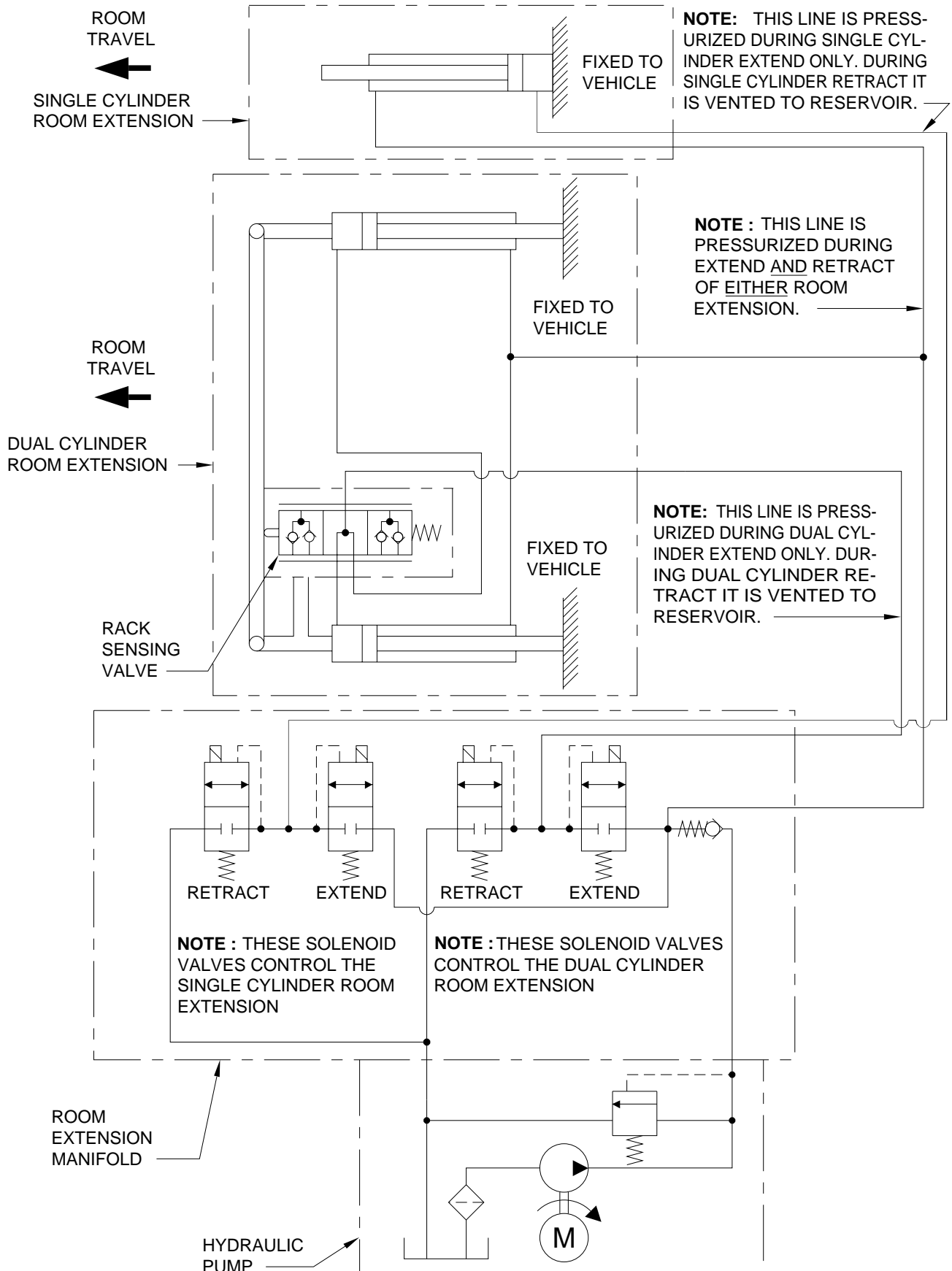

# REPAIR MANUAL

## ROOM EXTENSION OPERATOR PANEL

### MOTORIZED (REAR VIEW)

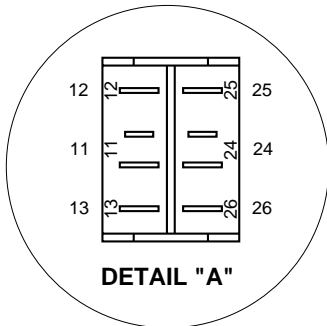
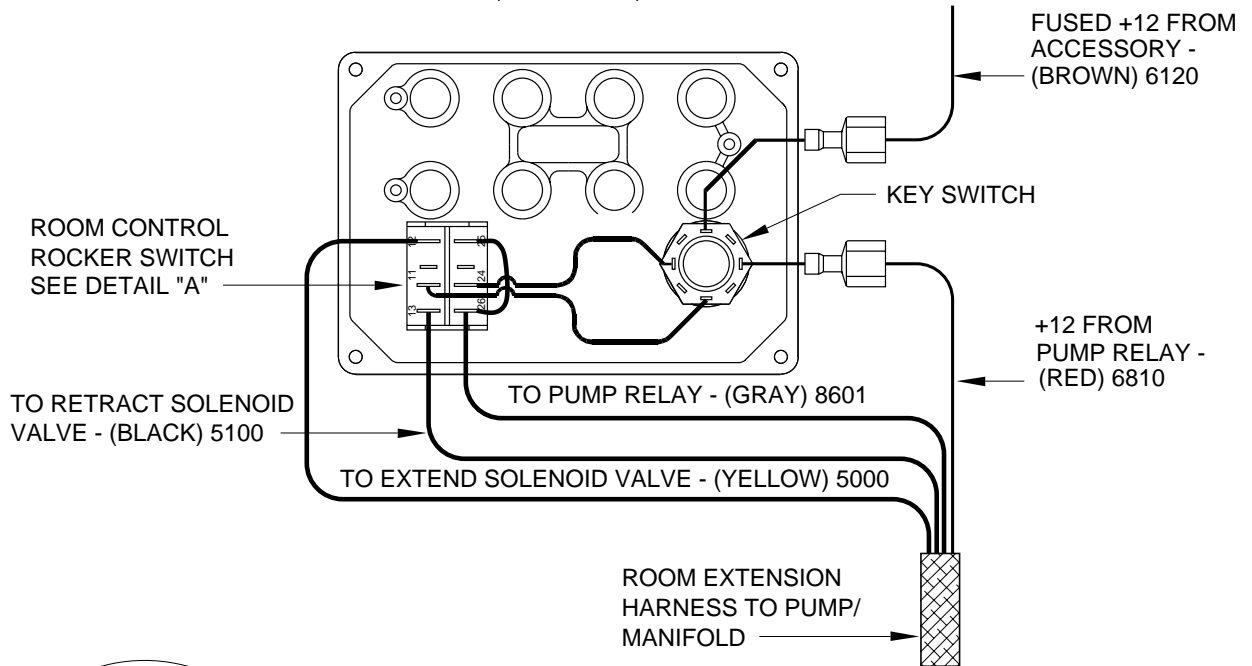

**NOTE:** THE (4) DIGIT WIRE NUMBER SUPERSEDES ANY AND ALL WIRE COLORS.

### NON-MOTORIZED (REAR VIEW)

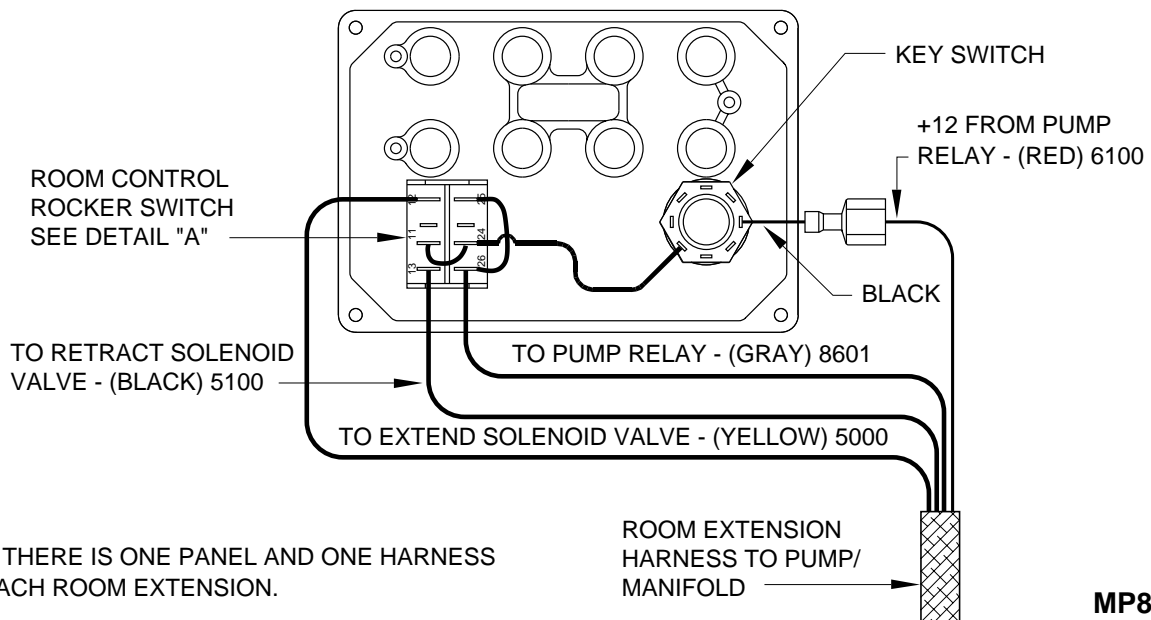

**NOTE:** THERE IS ONE PANEL AND ONE HARNESS FOR EACH ROOM EXTENSION.

# REPAIR MANUAL

## ROOM EXTENSION

### PUMP RELAY WIRING DIAGRAM

#### MOTORIZED

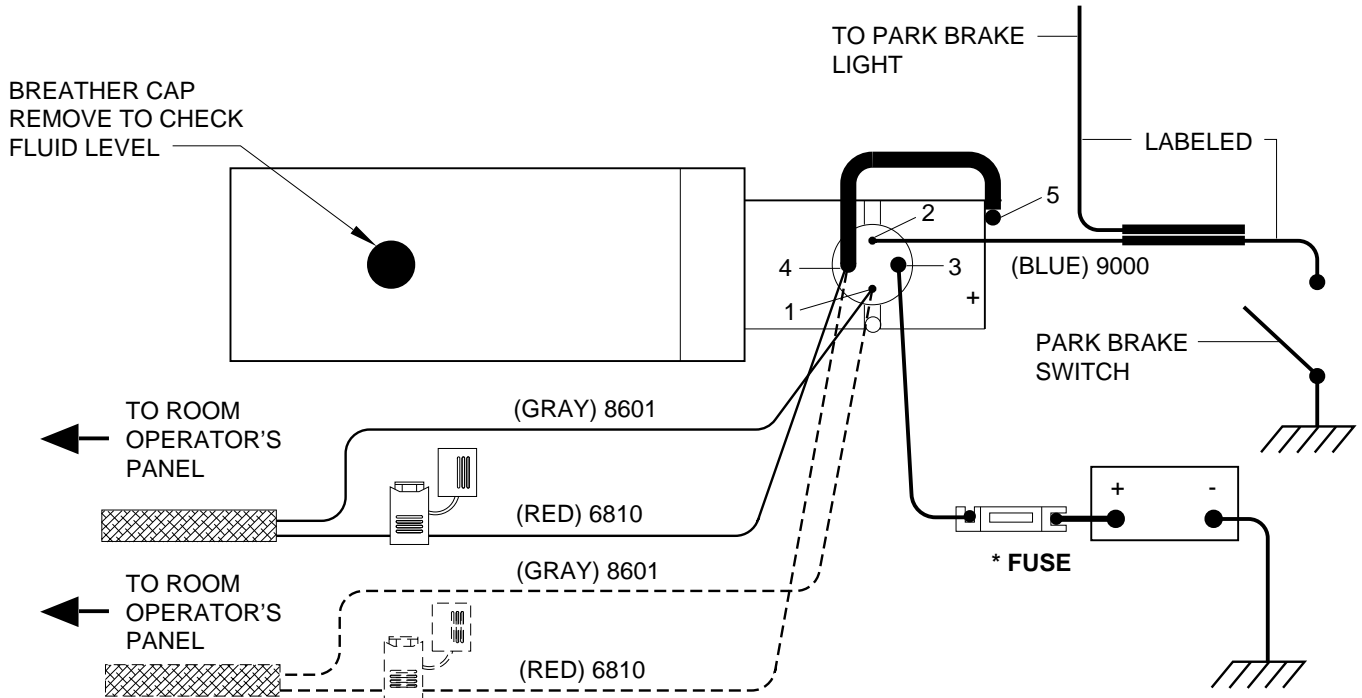

**NOTE:** SOME SYSTEMS CONNECT THE RED WIRE TO TERMINAL 4.

#### NON-MOTORIZED

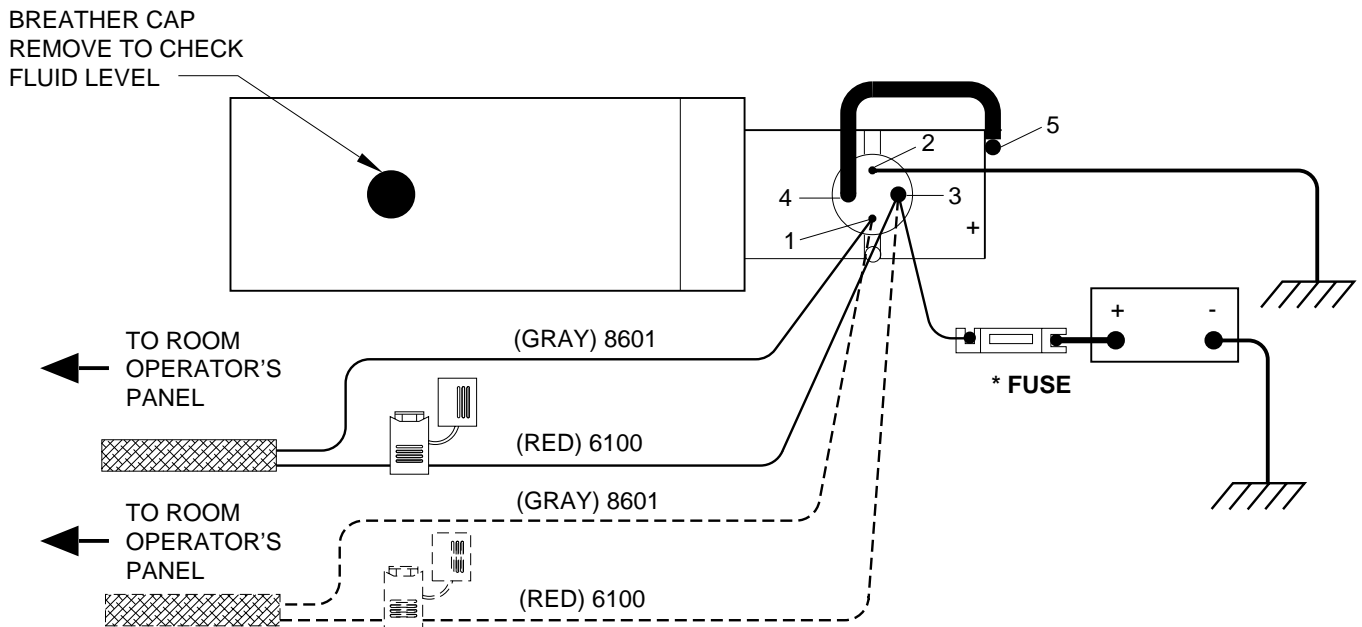

\* FUSE MAY BE REQUIRED - CHECK APPLICABLE CODE

**NOTE:** THERE IS A SEPARATE HARNESS FOR EACH ROOM EXTENSION

**NOTE:** THE (4) DIGIT WIRE NUMBER SUPERSEDES ANY AND ALL WIRE COLORS.

# REPAIR MANUAL

## ROOM EXTENSION SYSTEM

### HYDRAULIC MANIFOLD WIRING DIAGRAM

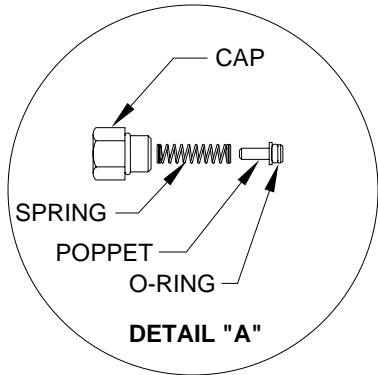

**NOTE:** EXTEND SOLENOID VALVES WILL ALWAYS BE A YELLOW AND A WHITE WIRE . THE RETRACT SOLENOID WILL ALWAYS BE A BLACK AND WHITE WIRE.

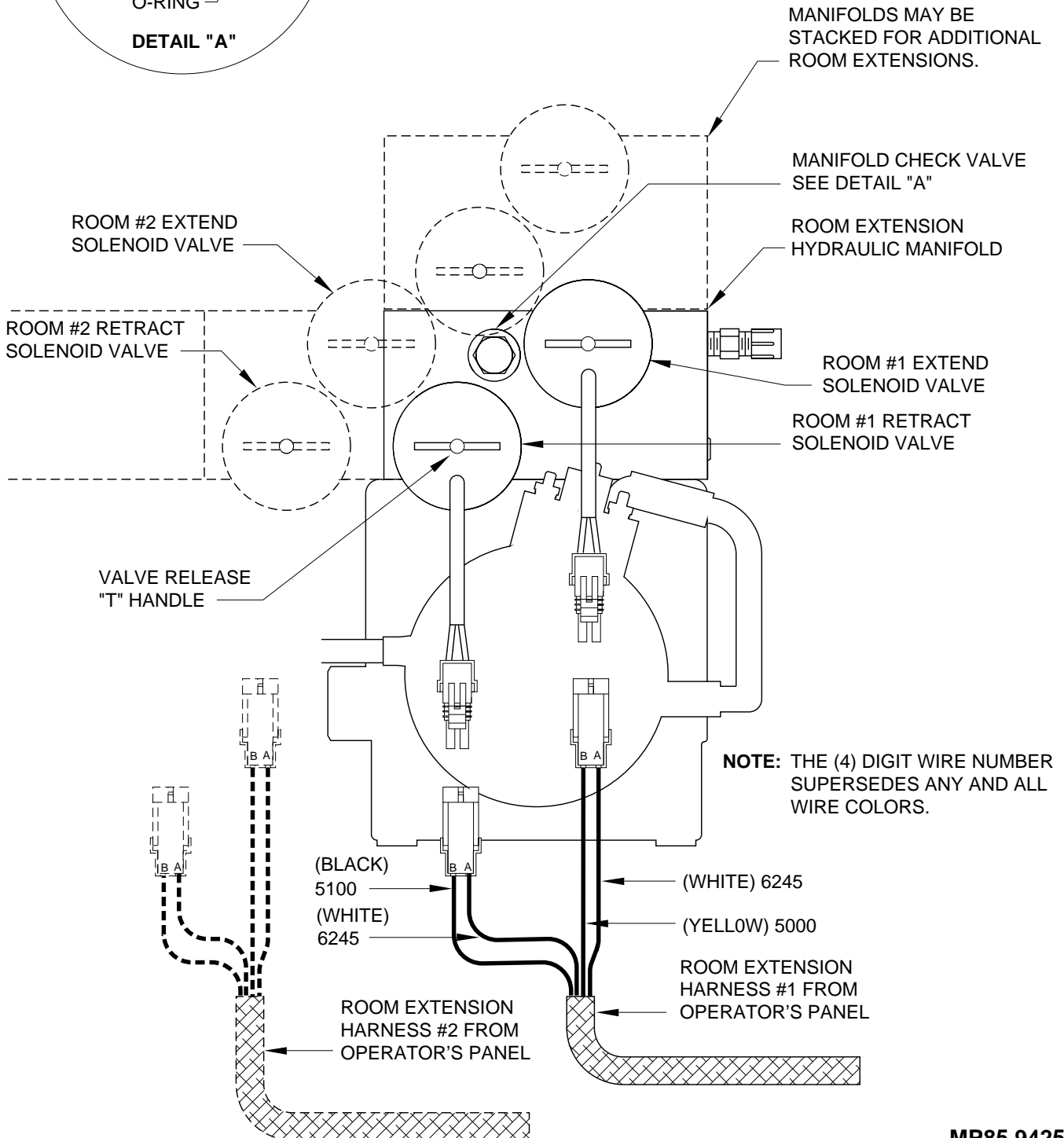

# REPAIR MANUAL ROOM EXTENSION GROUNDING INSTRUCTIONS

**NOTE:** THE (4) DIGIT WIRE NUMBER SUPERSEDES ANY AND ALL WIRE COLORS.

**NOTE:** IF THE PUMP BRACKET IS WELDED TO FRAME USE THE GROUND STUD TO ATTACH THE PUMP TO THE BRACKET. IF THE PUMP BRACKET IS BOLTED TO THE FRAME USE THE GROUND STUD TO ATTACH THE BRACKET TO THE FRAME.

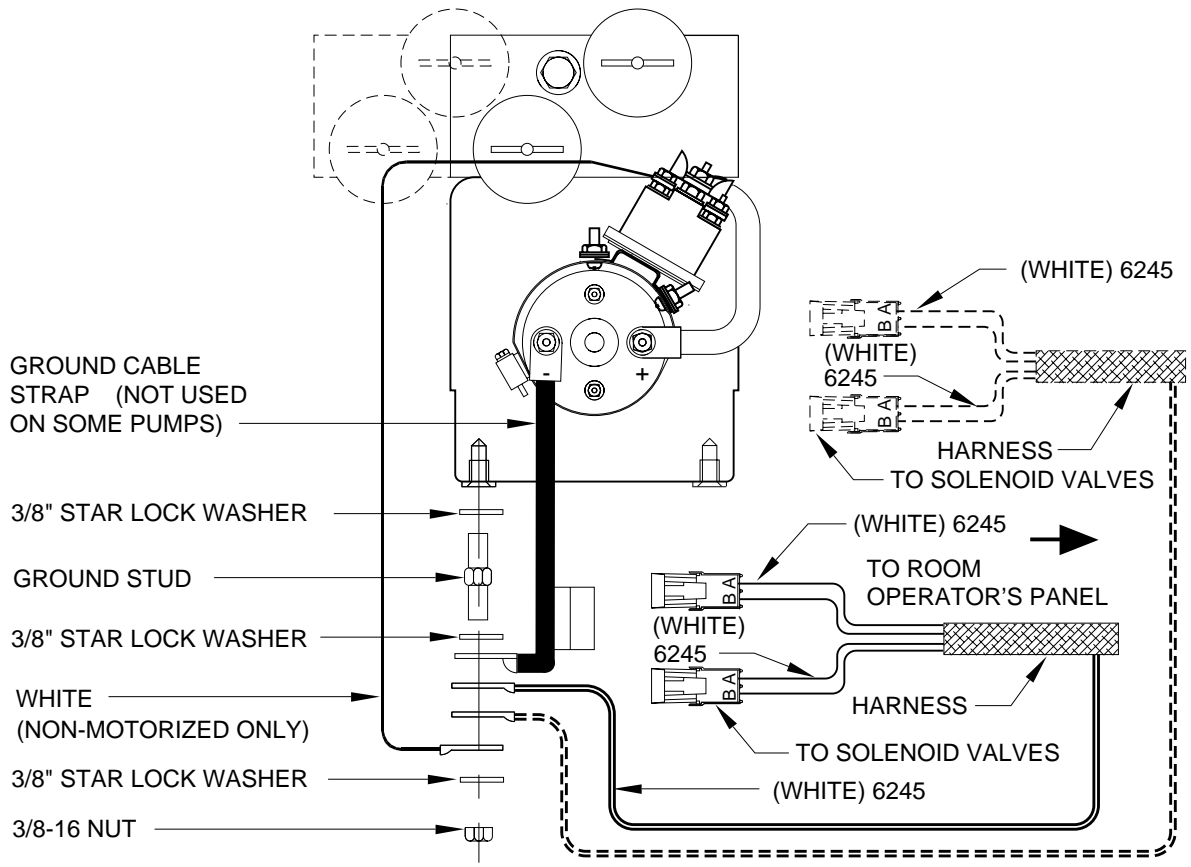

**NOTE:** THERE IS A SEPARATE HARNESS FOR EACH ROOM EXTENSION

# ELECTRICAL SCHEMATIC ROOM EXTENSION SYSTEM MOTORIZED

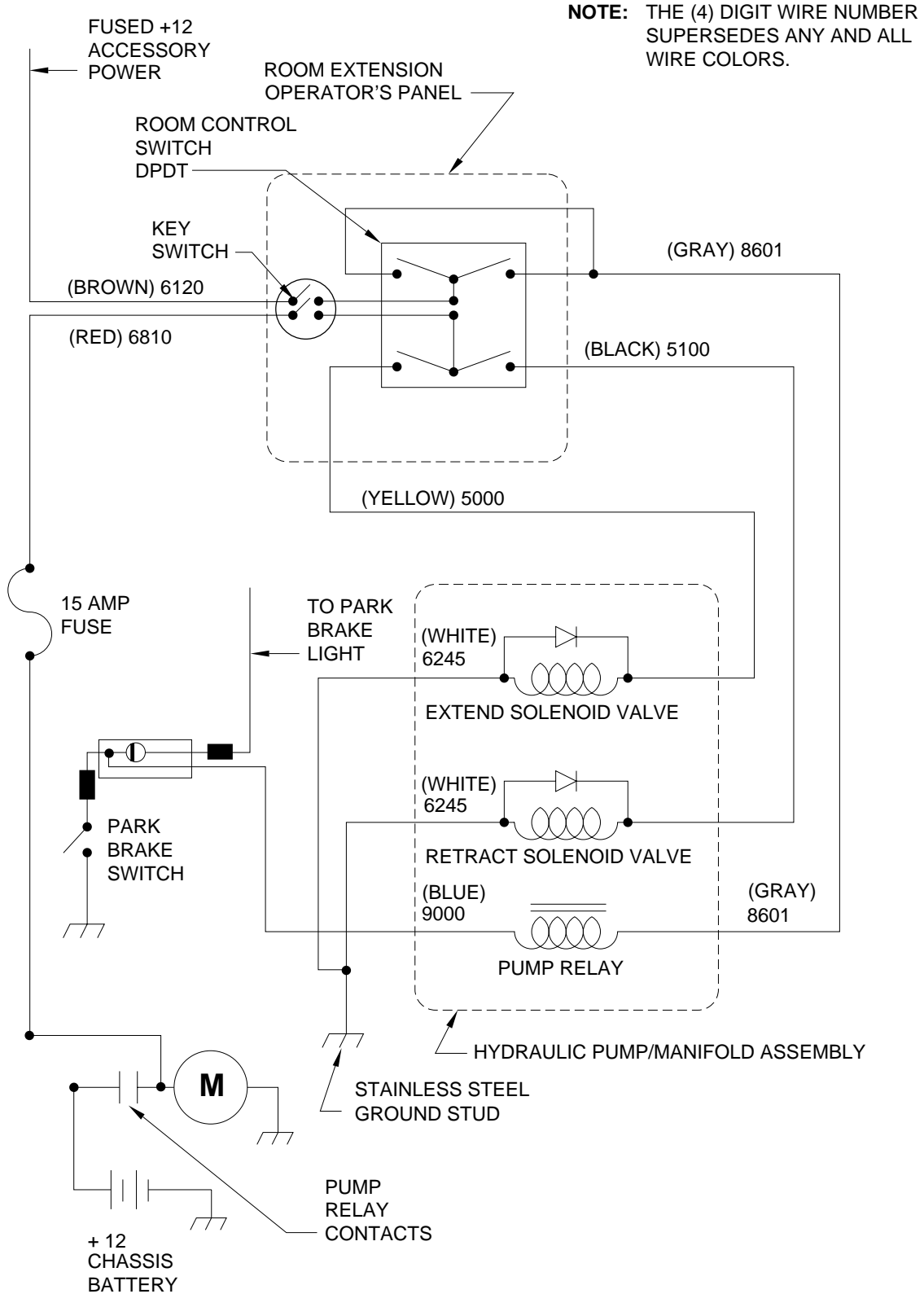

# ELECTRICAL SCHEMATIC ROOM EXTENSION SYSTEM NON-MOTORIZED

